



Giblor's
italian worklife specialist

Grembiule **RYAN**
pag. 140



RYAN

Dettagli / Details

- 2 tasche
- 1 taschino portapenne
- Allacciatura collo regolabile
- Inserti in Alcantara

- 2 pockets
- 1 pen pocket
- Adjustable halter
- Alcantara inserts

Taglie / Sizes

Taglia unica / One size

Art. 20P01H156

102 Verde militare / Military green
000 Nero / Black

Tessuto / Fabric

65% poliestere 35% cotone
65% polyester 35% cotton
200 g / m²

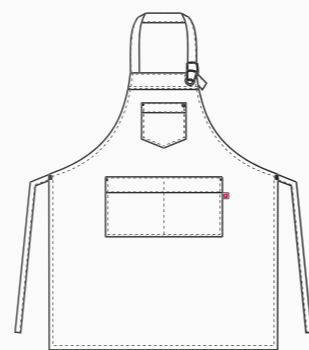

NICK

Dettagli / Details

- 1 tasca
- Inserti in Alcantara

- 1 pocket
- Alcantara inserts

Taglie / Sizes

Taglia unica / One size

Art. 20P08H187

102 Verde militare / Military green
000 Nero / Black

Tessuto / Fabric

65% poliestere 35% cotone
65% polyester 35% cotton
200 g / m²

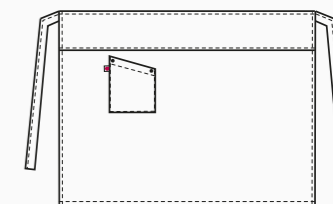

ANVERSA

Dettagli / Details

- 2 tasche
- Allacciatura collo regolabile con bottoni automatici

- 2 pockets
- Adjustable halter with press studs

Taglie / Sizes

Taglia unica / One size

Art. 17P01H919

004 Blu / Blue

Tessuto / Fabric

50% cotone 50% poliestere
50% cotton 50% polyester
180 g / m²

Misure / Dimensions

100x74 cm

Art. 17P01H906

004 Blu jeans / Blue jeans

Tessuto / Fabric

100% cotone / cotton
260 g / m²

Misure / Dimensions

100x74 cm

Art. 17P01H905

119 Grigio / Grey
002 Verde / Green

Tessuto / Fabric

65% poliestere 35% cotone
65% polyester 35% cotton
200 g / m²

Misure / Dimensions

100x74 cm

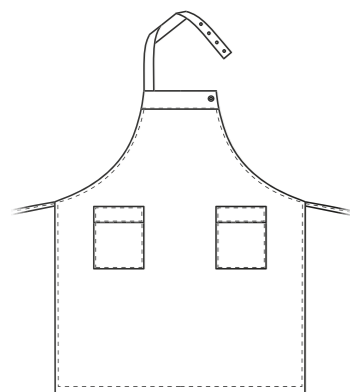

Art. 17P01H919
004 Blu / Blue



Art. 17P01H906
004 Blu jeans / Blue jeans



Art. 17P01H905
119 Grigio / Grey



Art. 17P01H905
002 Verde / Green



VIENNA

Dettagli / Details

- 1 grande tasca
- Allacciatura collo regolabile con bottoni automatici

- 1 big pocket
- Adjustable halter with press stud

Taglie / Sizes

Taglia unica / One size

Misure / Dimensions

100x68 cm

Art. 11P08H83B

00 Bianco / White

Art. 11P08H83

000 Nero / Black

Art. 11P08H83

119 Grigio / Grey

Art. 11P08H83

006 Bordeaux / Burgundy

Art. 11P08H83

3003F Rosso / Red

Art. 11P08H83

321 Bluette / Royal

Tessuto / Fabric

50% cotone 50% poliestere
50% cotton 50% polyester
180 g / m²



LUXSATIN EASY CARE

Art. 11P08H83B
00 Bianco / White



LUXSATIN EASY CARE

Art. 11P08H83
000 Nero / Black



LUXSATIN EASY CARE

Art. 11P08H83
119 Grigio / Grey



LUXSATIN EASY CARE

Art. 11P08H83
006 Bordeaux / Burgundy



LUXSATIN EASY CARE

Art. 11P08H83
3003F Rosso / Red



LUXSATIN EASY CARE

Art. 11P08H83
321 Bluette / Royal

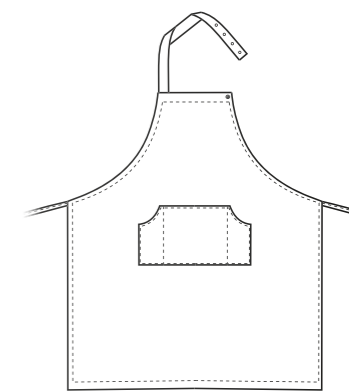

CANNES

Dettagli / Details

- 1 tasca
- Porta penne

- 1 pocket
- Pen pocket

Taglie / Sizes

Taglia unica / One size

Misure / Dimensions

90x75 cm

Art. 11P08H61

618 Gessato nero / Black
G119 Gessato grigio / Grey
01 Gessato Bordeaux / Burgundy
G004 Gessato blu / Blue

Tessuto / Fabric

100% cotone
100% cotton
140 g / m²



Art. 11P08H61
618 Gessato nero / Black



Art. 11P08H61
G119 Gessato grigio / Grey

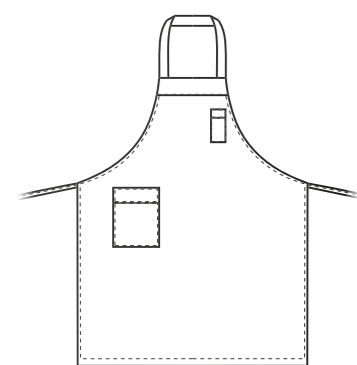

Art. 11P08H61
01 Gessato Bordeaux / Burgundy



Art. 11P08H61
G004 Gessato blu / Blue

LOUVRE

Dettagli / Details

- 1 tasca
- 1 portapenne

- 1 pocket
- 1 pen pocket

Taglie / Sizes

Taglia unica / One size

Misure / Dimensions

90x75 cm

Art. 19P08H61

R000 Rigato nero / Black striped
R119 Rigato grigio / Grey striped

Tessuto / Fabric

100% cotone
100% cotton
140 g / m²

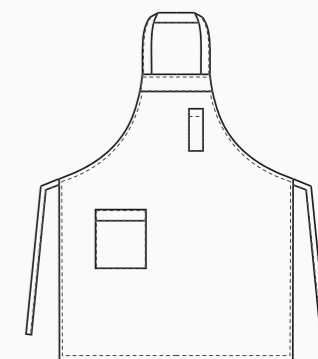

AMSTERDAM

Dettagli / Details

- 2 tasche
- 2 pockets

Taglie / Sizes

Taglia unica / One size

Misure / Dimensions

100x74 cm

Art. 19P01H440

033 Corallo / Coral
122 Bruciato / Burnt
214 Petrolio / Petroleum

Tessuto / Fabric

65% poliestere 35% cotone
65% polyester 35% cotton
200 g / m²



Art. 19P01H440
033 Corallo / Coral



Art. 19P01H440
122 Bruciato / Burnt



Art. 1100
000 Nero / Black



Art. 1100
006 Bordeaux / Burgundy

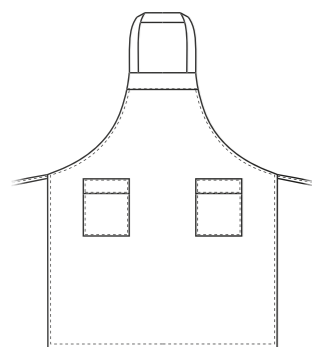

Art. 19P01H440
214 Petrolio / Petroleum



Art. 14P01H440
016 Tortora / Taupe



Art. 15P01H440
7014F Moka / Moka

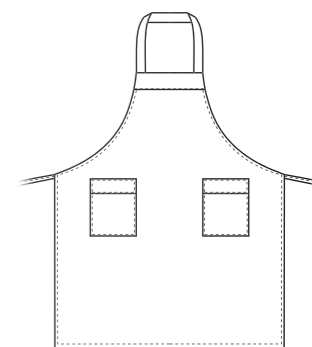

AMSTERDAM

Dettagli / Details

- 2 tasche
- 2 pockets

Taglie / Sizes

Taglia unica / One size

Art. 1100

000 Nero / Black
006 Bordeaux / Burgundy

Art. 14P01H440

016 Tortora / Taupe

Art. 15P01H440

7014F Moka / Moka

Tessuto / Fabric

65% poliestere 35% cotone
65% polyester 35% cotton
200 g / m²

Misure / Dimensions

100x74 cm



PRAGA

Dettagli / Details
- 1 tasca
- 1 pocket

Taglie / Sizes
Taglia unica / One size

Art. 8M1641
Art. 14P01H441
Art. 15P01H441
Art. 19P01H441

Misure / Dimensions
67x90 cm

Tessuto / Fabric
65% poliestere 35% cotone
65% polyester 35% cotton
200 g / m²

Art. 8M1641
000 Nero / Black
98x79 cm
200 g / m²



Art. 14P01H441
016 Tortora / Taupe
200 g / m²



Art. 15P01H441
7014F Moka / Moka
200 g / m²

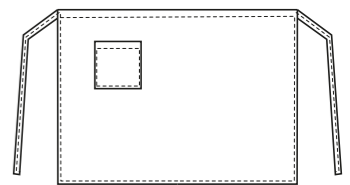

DUBLINO

Dettagli / Details
- 1 tasca
- 1 pocket

Taglie / Sizes
Taglia unica / One size

Misure / Dimensions
67x90 cm

Art. 18P01H969
077 Grigio Scuro / Dark Grey

Tessuto / Fabric
67% cotone 31% poliestere 2% elastan
67% cotton 31% polyester 2% elastane
170 g / m²

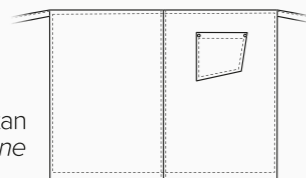

PRAGA

Dettagli / Details
- 1 tasca
- 1 pocket

Taglie / Sizes
Taglia unica / One size

Misure / Dimensions
67x90 cm

Art. 17P01H921
004 Blu / Blue

50% cotone 50% poliestere
50% cotton 50% polyester
180 g / m²

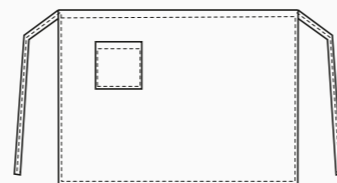

Art. 19P01H441
006 Bordeaux / Burgundy
200 g / m²



Art. 19P01H441
033 Corallo / Coral
200 g / m²



Art. 19P01H441
214 Petrolio / Petroleum blue
200 g / m²



Art. 19P01H441
122 Bruciato / Burnt
200 g / m²



ALESSANDRO

Dettagli / Details

- 1 Portapenne
- 1 Pen pocket

Taglie / Sizes Taglia unica / One size

Misure / Dimensions 90x90 cm



Art. 11P08H17
119 Grigio / Grey

Art. 11P08H17

119 Grigio / Grey

Art. 13P08H306

N/BCO Nero bianco / Black white

Art. 13P08H354

00 Bianco / White

Art. 19P08H17

005 Rosso / Red

50% cotone 50% poliestere
50% cotton 50% polyester
180 g / m²

LUXSATIN EASY CARE



Art. 13P08H306
N/BCO Nero bianco / Black white

65% poliestere 35% cotone
65% polyester 35% cotton
200 g / m²



Art. 15P08H306
000 Nero / Black

65% poliestere 35% cotone
65% polyester 35% cotton
200 g / m²



Art. 15P08H354
00 Bianco / White

100% cotone
100% cotton
185 g / m²



ALESSANDRO

Dettagli / Details

- 1 Portapenne
- 1 Pen pocket

Taglie / Sizes Taglia unica / One size

Misure / Dimensions 90x90 cm

Art. 15P08H306

000 Nero / Black

Art. 15P08H354

00 Bianco / White

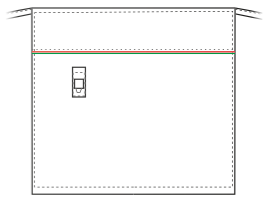

NICK

Dettagli / Details

- 1 Portapenne
- 1 Pen pocket

Taglie / Sizes Taglia unica / One size

Misure / Dimensions 90x90 cm

Art. 20P08H188

000 Nero / Black

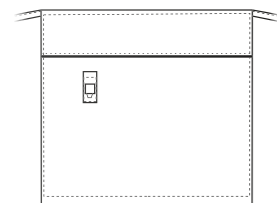
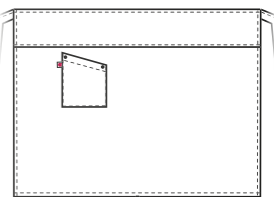

Art. 13P08H354
00 Bianco / White

100% cotone
100% cotton
185 g / m²



Art. 19P08H17
005 Rosso / Red

50% cotone 50% poliestere
50% cotton 50% polyester
180 g / m²

LUXSATIN EASY CARE



Art. 20P08H188
000 Nero / Black

65% poliestere 35% cotone
65% polyester 35% cotton
200 g / m²



Art. 19P08H108
J000 Jeans nero / Black jeans

75% cotone 23% poliestere 2% elasthan
75% cotton 23% polyester 2% elasthan
210 g / m²



OMERO

Dettagli / Details

- 1 Portapenne
- 1 Pen pocket

Taglie / Sizes Taglia unica / One size

Misure / Dimensions 90x90 cm

Art. 19P08H108

J000 Jeans Nero / Black Jeans

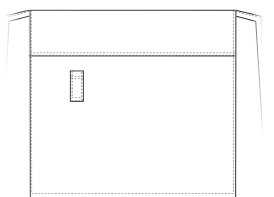



PARIGI

Dettagli / Details

- Stampato
- 1 tasca

- Printed fabric
- 1 pocket

Taglie / Sizes

Taglia unica / One size

Misure / Dimensions

90x70 cm

Art. 19P08H478

F014 Travel / Travel

Tessuto / Fabric

100% cotone
100% cotton
180 g / m²

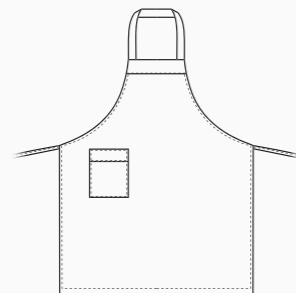

PRAGA

Dettagli / Details

- Stampato
- 1 tasca

- Printed fabric
- 1 pocket

Taglie / Sizes

Taglia unica / One size

Misure / Dimensions

70x70 cm

Art. 19P08H480

F014 Travel / Travel

Tessuto / Fabric

100% cotone
100% cotton
180 g / m²

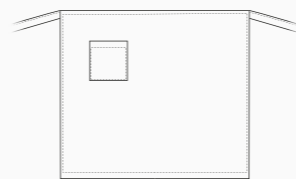

PARIGI

Dettagli / Details

- Stampato
- 1 tasca

- Printed fabric
- 1 pocket

Taglie / Sizes

Taglia unica / One size

Misure / Dimensions

90x70 cm

Art. 19P08H478

F013 Gufi indiani / Indian owls

Tessuto / Fabric

100% cotone
100% cotton
180 g / m²

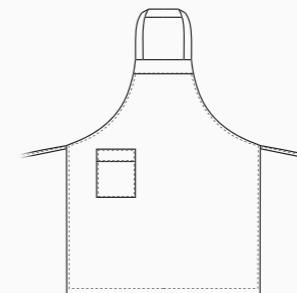

PRAGA

Dettagli / Details

- Stampato
- 1 tasca

- Printed fabric
- 1 pocket

Taglie / Sizes

Taglia unica / One size

Misure / Dimensions

70x70 cm

Art. 19P08H480

F013 Gufi indiani / Indian owls

Tessuto / Fabric

100% cotone
100% cotton
180 g / m²

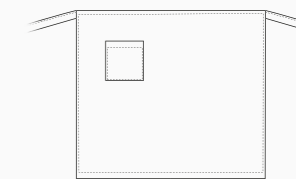

ACCESSORI COORDINABILI
COORDINABLE ACCESSORIES

pag. 365 - 368

ACCESSORI COORDINABILI
COORDINABLE ACCESSORIES

pag. 365 - 368

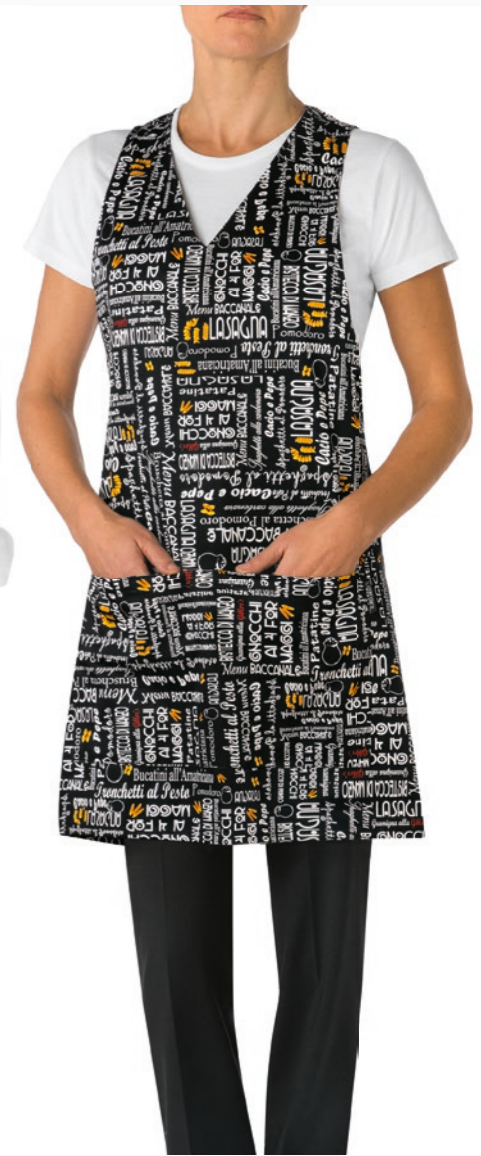

PARIGI

Dettagli / Details

- Stampato
- 1 tasca

- Printed fabric
- 1 pocket

Taglie / Sizes

Taglia unica / One size

Misure / Dimensions

90x70 cm

Art. 16P08H478

F009 Fumetto / Comics

Tessuto / Fabric

100% cotone
100% cotton
180 g / m²

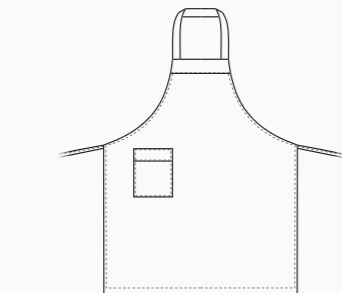

ZAGABRIA

Dettagli / Details

- Stampato
- 1 tasca

- Printed fabric
- 1 pocket

Taglie / Sizes

Taglia unica / One size

Misure / Dimensions

70x70 cm

Art. 16P08H480

F009 Fumetto / Comics

Tessuto / Fabric

100% cotone
100% cotton
180 g / m²

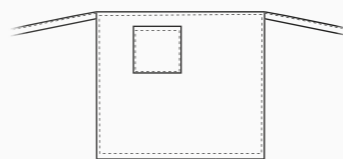

PARIGI

Dettagli / Details

- Stampato - 1 tasca
- Printed fabric - 1 pocket

Taglie / Sizes Taglia unica / One size

Misure / Dimensions 90x70 cm

Art. 14P08H478

Menu nero / Black menu

Tessuto / Fabric

100% cotone / 100% cotton - 180 g / m²

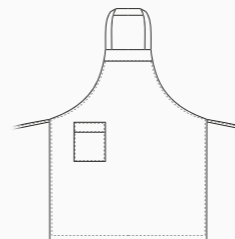

ZAGABRIA

Dettagli / Details

- Stampato - 1 tasca
- Printed fabric - 1 pocket

Taglie / Sizes Taglia unica / One size

Misure / Dimensions 70x70 cm

Art. 14P08H480

Menu nero / Black menu

Tessuto / Fabric

100% cotone / 100% cotton - 180 g / m²

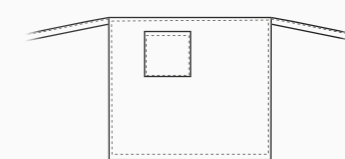

LONDON

Dettagli / Details

- Scamiciato - Coperto dietro
- 1 grande tasca
- Pinafore - Covered backside
- 1 big pocket

Taglie / Sizes Taglia unica / One size

Art. 14P08H479

Menu nero / Black menu

Tessuto / Fabric

100% cotone / 100% cotton - 180 g / m²

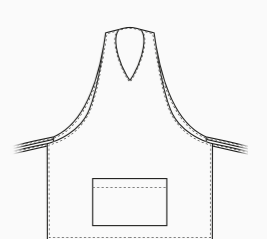

ACCESSORI COORDINABILI
COORDINABLE ACCESSORIES

pag. 366 - 368

ACCESSORI COORDINABILI
COORDINABLE ACCESSORIES

pag. 366 - 368

SAN PIETROBURGO

Dettagli / Details

- 2 tasche
- Allacciatura collo regolabile con bottoni automatici

- 2 pockets
- Adjustable halter with press studs

Taglie / Sizes Taglia unica / One size

Misure / Dimensions 100x100 cm

Art. 17P01H907

00 Bianco / White

Tessuto / Fabric

100% cotone / 100% cotton
185 g / m²

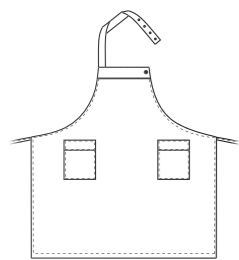

BIG
100 CM



Art. 17P01H909

000 Nero / Black

65% poliestere 35% cotone
65% polyester 35% cotton
200 g / m²

Misure / Dimensions
100x100 cm



MOSCA

Dettagli / Details

- 1 tasca

- 1 pocket

Taglie / Sizes Taglia unica / One size

Misure / Dimensions 70x100 cm

Art. 17P01H908

00 Bianco / White

Tessuto / Fabric

100% cotone
100% cotton
185 g / m²

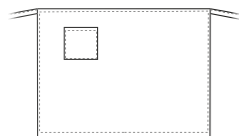

BIG
100 CM



Art. 8M1641

000 Nero / Black

65% poliestere / 35% cotone
65% polyester / 35% cotton
200 g / m²

Misure / Dimensions
98x79 cm



Art. 407

75x100 cm



Art. 408

80x105 cm



Art. 406

45x80 cm



Art. 407E

70x90 cm



Art. 408E

72x100 cm



Art. 406E

40x80 cm



GREMBIULE

Dettagli / Details

- 1 tasca
- 1 pocket

Taglie / Sizes

Taglia unica / One size

Art. 407

Art. 408

Art. 406

00 Bianco / White

Tessuto / Fabric

100% cotone
100% cotton
230 g / m²

GREMBIULE ECONOMICO

Dettagli / Details

- Senza tasca
- Without pocket

Taglie / Sizes

Taglia unica / One size

Art. 407E

00 Bianco / White

Tessuto / Fabric

100% cotone
100% cotton
185 g / m²

Art. 408E

Art. 406E

00 Bianco / White

Tessuto / Fabric

100% cotone
100% cotton
230 g / m²

& Ho.Re.Ca. SERVICES

Il lavoro con il pubblico è fatto di sollecitudine, dedizione e piccole attenzioni. Si realizza appieno nel delicato equilibrio tra dettagli classici e gradite sorprese.

Working with the public is made of solicitude, dedication and small attentions. It is fully realized in the delicate balance between classic details and pleasant surprises.

Esattamente ciò che la linea **Giblor's Ho.Re.Ca & Services** offre a te, che ti dedichi ad offrire servizi capaci di accendere il sorriso sul volto di ogni cliente. Anche il più esigente.

*Exactly what the **Giblor's line Ho.Re.Ca & Services** offers a you, dedicated to offering services capable of light up the smile on every customer's face. Even the most demanding.*

Capi eleganti e funzionali, con una vestibilità perfetta e con la massima coordinabilità: abbiamo creato per te una collezione ampia e varia, che spazia da pezzi senza tempo alle ultime novità del design.

Elegant and functional garments, with a perfect fit and with maximum coordination: we have created an extensive collection for you and varied, ranging from timeless pieces to latest design news.

Il mix perfetto tra impegno e stile.

The perfect mix between commitment and style.

Giblor's
italian worklife specialist

La passione per il lavoro e la voglia di migliorare porta spesso a piccole e grandi trasformazioni. Idee che nascono e si definiscono con l'obiettivo di accompagnarti sempre più vicino ai tuoi desideri. È per questo che la collezione Giblor's 2020 introduce una novità: la divisione per linee. Una scelta utile a definire meglio la crescente quantità di capi disponibili. Attraverso queste tre categorie ti accompagniamo nella scelta dello stile che più ti rappresenta o quello che senti più affine al tuo stato d'animo, o più adatto alle esigenze di uno specifico ambiente di lavoro. Per poter sempre essere te stesso. Al meglio.

Elegance
COLLECTION
Glamour
COLLECTION
Evergreen
COLLECTION

The passion for work and the desire to improve often leads to small and large transformations. Ideas that are born and defined with the goal to accompany you ever closer to yours wishes. This is why the Giblor's 2020 collection introduces a novelty: the division by lines. A useful choice to better define the growing quantity of garments available. Through these three categories you will be accompany in the choice of the style that most represents you or what you feel closest to yours state of mind, or more suited to one's needs specific work environment. In order to always be yourself. To the best.



Capi perfetti per te, che vivi il lavoro come un impegno teso ad offrire la massima eccellenza.

Grembiuli e gilet con tessuti ricercati e linea studiata nei minimi dettagli, per indossare ogni capo come un abito su misura.

Se ti muovi in un ambiente da vivere come un viaggio nel lusso,

G'Elegance è la collezione giusta per te.

Elegance

COLLECTION

Perfect garments for you, that experience work as a commitment aimed at offering the utmost excellence.

Aprons and vests with refined fabrics and lines studied in detail, to wear every garment as a tailored suit.

If you move in an environment to live like a journey into luxury,

G' Elegance is the collection right for you.

ho.re.ca.
& services

Brigata Casa Maria Luigia, Modena



UNCHANGE

TECH



UNCHANGE

TECH



LUXSATIN

BIG
100 CM

EASY CARE



LUXSATIN

BIG
100 CM

EASY CARE



BRASSERIE

Dettagli / Details

- 1 tasca
- 1 pocket

Taglie / Sizes

Taglia unica / One size

Misure / Dimensions

100x100 cm

Art. 552

000 Nero / Black

Tessuto / Fabric

100% poliestere
100% polyester
220 g / m²

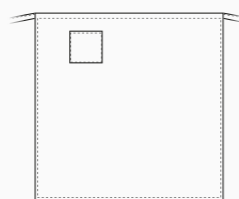

PETRA

Dettagli / Details

- Foderato - 2 tasche
- 4 bottoni - Fascette regolabili

- Lined - 2 pockets

- 4 buttons - Adjustable buckle

Taglie / Sizes

XS ÷ XXL Slim Fit

Art. 7M108

000 Nero / Black

Tessuto / Fabric

100% poliestere
100% polyester
170 g / m²

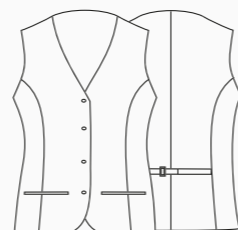

PERTH

Dettagli / Details

- 2 tasche
- Spacco centrale

- 2 pockets

- Split in the middle

Taglie / Sizes

Taglia unica / One size

Misure / Dimensions

100x100 cm

Art. 18P01H055

000 Nero / Black
119 Grigio / Grey

Tessuto / Fabric

50% cotone 50% poliestere
50% cotton 50% polyester
180 g / m²

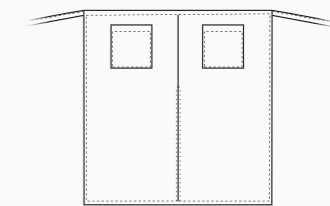



FRANCISCA

Dettagli / Details

- Foderato - 2 tasche in contrasto
- 4 bottoni - Fascette regolabili

- Lined
- 2 contrasted pockets
- 4 buttons
- Adjustable buckle

Taglie / Sizes

XS ÷ XXL Slim Fit

Art. 11P01E77

P170 Polvere / Dusty grey

Tessuto / Fabric

100% poliestere
100% polyester
220 g / m²

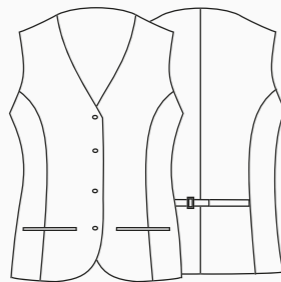

MIGUEL

Dettagli / Details

- Foderato - 2 tasche in contrasto
- 4 bottoni - Fascette regolabili

- Lined
- 2 contrasted pockets
- 4 buttons
- Adjustable buckle

Taglie / Sizes

XS ÷ XXXL Regular Fit

Art. 11P01E76

P170 Polvere / Dusty grey

Tessuto / Fabric

100% poliestere
100% polyester
220 g / m²



BOB

Dettagli / Details

- 1 tasca
- 1 pocket

Taglie / Sizes Taglia unica / One size

Misure / Dimensions 80x98

Art. 11P01H26

P170 Polvere / Dusty grey

Tessuto / Fabric

100% poliestere / polyester - 220 g / m²

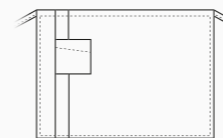

DEMIDOFF

Dettagli / Details

- 1 tasca
- Allacciatura collo regolabile con velcro
- 1 pocket
- Adjustable halter with velcro

Taglie / Sizes Taglia unica / One size

Art. 11P01H27

P170 Polvere / Dusty grey

Tessuto / Fabric

100% poliestere / polyester - 220 g / m²

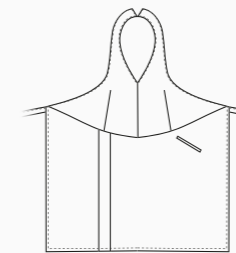

RAISSA

Dettagli / Details

- 2 tasche
- Allacciatura collo regolabile con velcro
- 2 pockets
- Adjustable halter with velcro

Taglie / Sizes Taglia unica / One size

Art. 11P01H25

P170 Polvere / Dusty grey

Tessuto / Fabric

100% poliestere / polyester - 220 g / m²

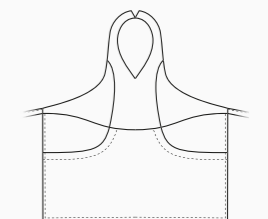

EASY CARE



EASY CARE



EASY CARE



EASY CARE



BARNEY

Dettagli / Details

- 1 grande tasca - Taschino portapenne
- Allacciatura collo regolabile con 3 asole
- Spacco laterale

- 1 big pocket - Pen pocket
- Adjustable halter with 3 button holes
- Side vent

Taglie / Sizes

Taglia unica / One size

Art. 18P01H058

077 Grigio scuro / Dark grey

Tessuto / Fabric

67% cotone 31% poliestere
2% elasthan
67% cotton 31% polyester
2% elastane
170 g / m²

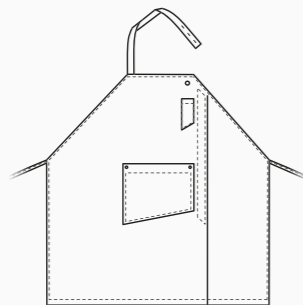

ELETTRA

Dettagli / Details

- 1 tasca
- Allacciatura collo regolabile con velcro

- 1 pocket
- Adjustable halter with velcro

Taglie / Sizes

Taglia unica / One size

Art. 18P01H904

077 Grigio scuro / Dark grey

Tessuto / Fabric

67% cotone 31% poliestere
2% elasthan
67% cotton 31% polyester
2% elastane
170 g / m²

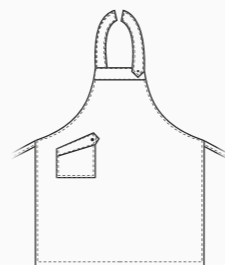

DUBLINO

Dettagli / Details

- 1 tasca
- 1 pocket

Taglie / Sizes

Taglia unica / One size

Misure / Dimensions

67x90 cm

Art. 18P01H969

077 Grigio scuro / Dark grey

Tessuto / Fabric

67% cotone 31% poliestere
2% elasthan
67% cotton 31% polyester
2% elastane
170 g / m²

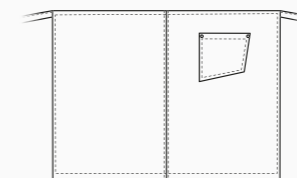

WILMA

Dettagli / Details

- 2 tasche - Coperto dietro
- Allacciatura collo regolabile con 4 bottoni

- 2 pockets - Covered backside
- Adjustable halter with 4 buttons

Taglie / Sizes

Taglia unica / One size

Art. 18P01H968

077 Grigio scuro / Dark grey

Tessuto / Fabric

67% cotone 31% poliestere
2% elasthan
67% cotton 31% polyester
2% elastane
170 g / m²

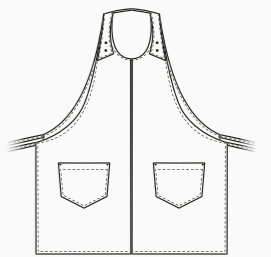



MONTRESOR

Dettagli / Details

- 2 tasche
- Taschino portapenne
- Allacciatura collo regolabile

- 2 pockets
- Pen pocket
- Adjustable halter

Taglie / Sizes

Taglia unica / One size

Art. 19P01H083

00 Bianco / White

Art. 19P01H068

322 Marrone / Brown
118 Azzurro / Light blu

Tessuto / Fabric

55% lino 45% cotone
55% linen 45% cotton
235 g / m²

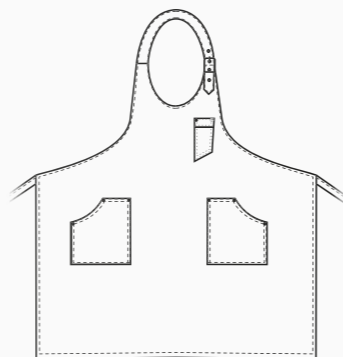

Art. 19P01H083
118 Azzurro / Light blue



LUXSATIN

EASY CARE



LUXSATIN

EASY CARE



ELETTRA

Dettagli / Details

- 1 tasca
- Allacciatura collo regolabile con velcro
- 1 pocket
- Adjustable halter with velcro

Taglie / Sizes Taglia unica / One size

Art. 14P02H457

322 Marrone / Brown

Tessuto / Fabric

55% lino 45% cotone
55% linen 45% cotton
235 g / m²

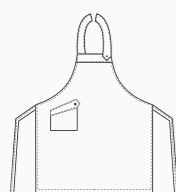

AMSTERDAM

Dettagli / Details

- 2 tasche
- 2 pockets

Taglie / Sizes Taglia unica / One size

Art. 14P01H445

322 Marrone / Brown

Tessuto / Fabric

55% lino 45% cotone
55% linen 45% cotton
235 g / m²

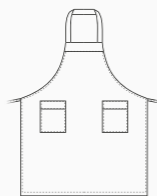

ACCESSORI COORDINABILI
COORDINABLE ACCESSORIES
pag. 376

ZAGABRIA

Dettagli / Details

- 1 tasca
- 1 pocket

Taglie / Sizes Taglia unica / One size

Misure / Dimensions 76,5x79 cm

Art. 14P01H444

322 Marrone / Brown

Tessuto / Fabric

55% lino 45% cotone
55% linen 45% cotton
235 g / m²



ANVERSA

Dettagli / Details

- 2 tasche
- Allacciatura collo regolabile con bottoni automatici
- 2 pockets
- Adjustable halter with press studs

Taglie / Sizes Taglia unica / One size

Art. 17P01H919

004 Blu / Blue

Tessuto / Fabric

50% cotone 50% poliestere
50% cotton 50% polyester
180 g / m²

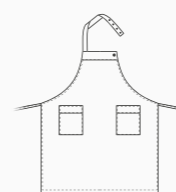

ELETTRA

Dettagli / Details

- 1 tasca
- Allacciatura collo regolabile con velcro
- 1 pocket
- Adjustable halter with velcro

Taglie / Sizes Taglia unica / One size

Art. 17P01H920

004 Blu / Blue

Tessuto / Fabric

50% cotone 50% poliestere
50% cotton 50% polyester
180 g / m²

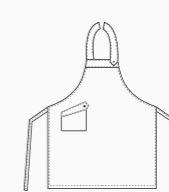

ACCESSORI COORDINABILI
COORDINABLE ACCESSORIES
pag. 376

PRAGA

Dettagli / Details

- 1 tasca
- 1 pocket

Taglie / Sizes Taglia unica / One size

Misure / Dimensions 67x90 cm

Art. 17P01H921

004 Blu / Blue

Tessuto / Fabric

50% cotone 50% poliestere
50% cotton 50% polyester
180 g / m²

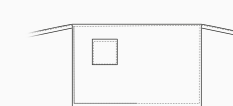

VIENNA

Dettagli / Details

- 3 tasche
- Allacciatura collo regolabile con bottoni automatici

- 3 pockets
- Adjustable halter with press studs

Taglie / Sizes

Taglia unica / One size

Art. 11P08H83

119 Grigio / Grey
000 Nero / Black
006 Bordeaux / Burgundy
3003F Rosso / Red
321 Bluette / Royal

Art. 11P08H83B

00 Bianco / White

Tessuto / Fabric

50% cotone 50% poliestere
50% cotton 50% polyester
180 g / m²

LUXSATIN

EASY CARE

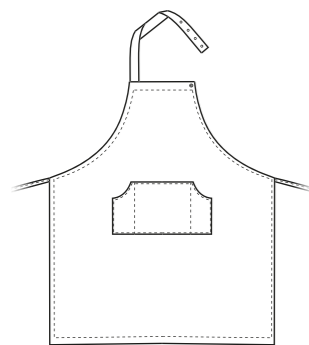

Art. 11P08H83B
00 Bianco / White



LUXSATIN EASY CARE



Art. 11P08H83
000 Nero / Black

LUXSATIN EASY CARE



Art. 11P08H83
119 Grigio / Grey

LUXSATIN EASY CARE



Art. 11P08H83
006 Bordeaux / Burgundy

LUXSATIN EASY CARE



Art. 11P08H83
3003F Rosso / Red

LUXSATIN EASY CARE



Art. 11P08H83
321 Bluette / Royal

LUXSATIN EASY CARE



16P01H814 - 16P01H819 - 16P01H813



ARMATURA IN CANVAS, RESISTENTE
ALLO SFREGAMENTO
E DIFFICILMENTE USURABILE

STRONG WEAVING, HARDLY SUBJECT
TO WEAR AND TEAR

CHARLIE

Dettagli / Details

- 4 tasche
- 4 pockets

Taglie / Sizes

Taglia unica / One size

Misure / Dimensions 30x70 cm

Art. 16P01H819

000 Nero / Black

Tessuto / Fabric

65% poliestere 35% cotone
65% polyester 35% cotton
310 g / m²



PRAGA

Dettagli / Details

- 1 tasca
- 1 pocket

Taglie / Sizes

Taglia unica / One size

Misure / Dimensions 62x83 cm

Art. 16P01H814

000 Nero / Black

Tessuto / Fabric

65% poliestere 35% cotone
65% polyester 35% cotton
310 g / m²

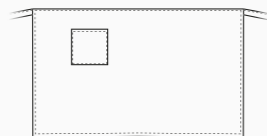

ANVERSA

Dettagli / Details

- 2 tasche
- Allacciatura collo regolabile
con bottoni automatici

- 2 pockets
- Adjustable halter with
press studs

Taglie / Sizes

Taglia unica / One size



Art.16P01H813

000 Nero / Black

Tessuto / Fabric

65% poliestere 35% cotone
65% polyester 35% cotton
310 g / m²

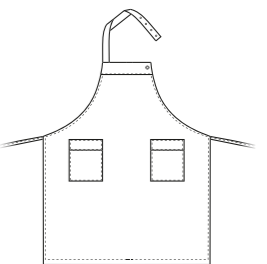
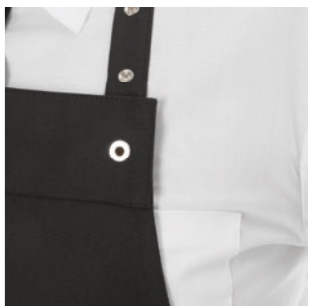



TROPEZ

Dettagli / Details

- 2 tasche
- 1 taschino portapenne
- Allacciatura collo regolabile
- Inserti in Alcantara
- Anello porta torcione

- 2 pockets
- 1 pen pocket
- Adjustable halter
- Alcantara inserts
- Cloth ring

Taglie / Sizes

Taglia unica / One size

Art. 20P01H149

073 Beige / Beige
322 Marrone / Brown
019 Grigio / Grey

Tessuto / Fabric

100% poliestere
100% polyester
170 g / m²

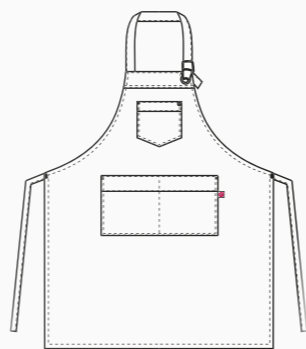

Art. 20P01H149
019 Grigio / Grey



NAPOLI

Dettagli / Details

- 1 tasca

- 1 pocket

Taglie / Sizes

Taglia unica / One size

Art. 20P01H147

322 Marrone / Brown

Tessuto / Fabric

100% poliestere
100% polyester
170 g / m²

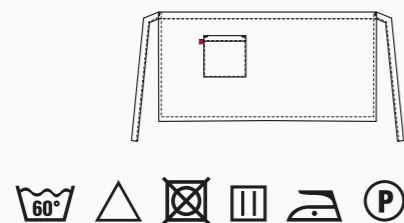

RENO

Dettagli / Details

- 2 tasche - 1 taschino portapenne
- Allacciatura collo regolabile con bottoni

- 2 pockets - 1 pen pocket
- Adjustable halter with buttons

Taglie / Sizes

Taglia unica / One size

Art. 20P01H158

322 Marrone / Brown

Tessuto / Fabric

100% poliestere
100% polyester
170 g / m²

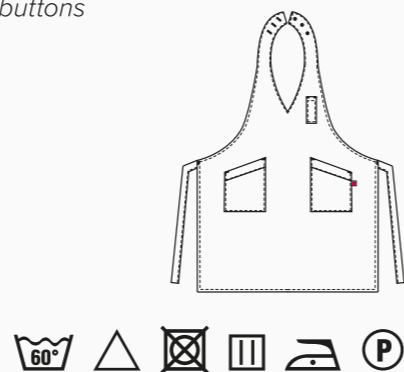

LIONE

Dettagli / Details

- 1 tasca

- 1 pocket

Taglie / Sizes

Taglia unica / One size

Art. 20P01H159

322 Marrone / Brown

Tessuto / Fabric

100% poliestere
100% polyester
170 g / m²

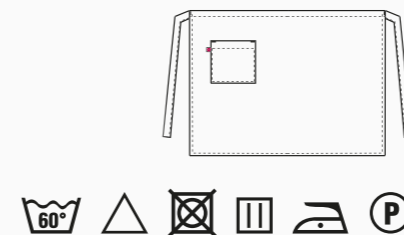

SCOTLAND

Dettagli / Details

- 1 grande tasca - 1 taschino portapenne
- Allacciatura collo regolabile con bottoni

- 1 big pocket - 1 pen pocket
- Adjustable halter with buttons

Taglie / Sizes

Taglia unica / One size

Art. 20P01H2055

322 Marrone / Brown

Tessuto / Fabric

100% poliestere
100% polyester
170 g / m²

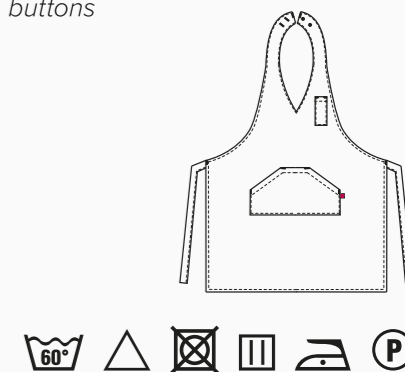



NAPOLI

Dettagli / Details

- 1 tasca

- 1 pocket

Taglie / Sizes

Taglia unica / One size

Art. 20P01H147

073 Beige / Beige

Tessuto / Fabric

100% poliestere
100% polyester
170 g / m²

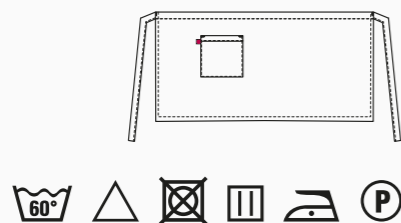

RENO

Dettagli / Details

- 2 tasche - 1 taschino portapenne
- Allacciatura collo regolabile

- 2 pockets - 1 pen pocket
- Adjustable halter

Taglie / Sizes

Taglia unica / One size

Art. 20P01H158

073 Beige / Beige

Tessuto / Fabric

100% poliestere
100% polyester
170 g / m²

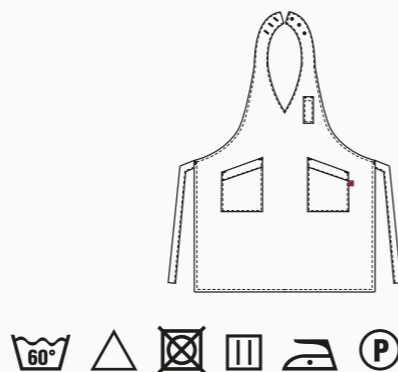

LIONE

Dettagli / Details

- 1 tasca

- 1 pocket

Taglie / Sizes

Taglia unica / One size

Art. 20P01H159

073 Beige / Beige

Tessuto / Fabric

100% poliestere
100% polyester
170 g / m²

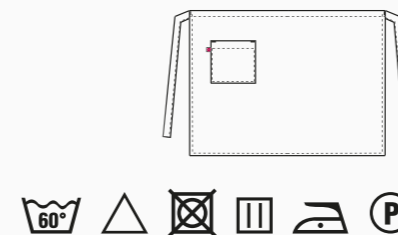

SCOTLAND

Dettagli / Details

- 1 grande tasca - 1 taschino portapenne
- Allacciatura collo regolabile con bottoni

- 1 big pocket - 1 pen pocket
- Adjustable halter with buttons

Taglie / Sizes

Taglia unica / One size

Art. 20P01H2055

073 Beige / Beige

Tessuto / Fabric

100% poliestere
100% polyester
170 g / m²

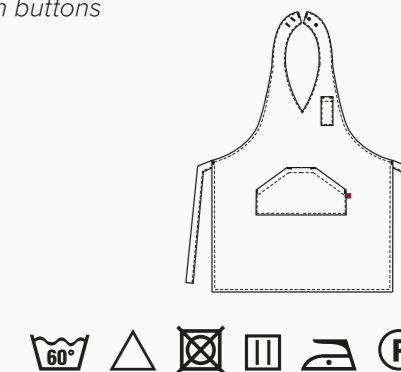

Grembiule **LIONE**
pag. 202

ACCESSORI
pag. 356

Grembiule **SCOTLAND**
pag. 202



NAPOLI

Dettagli / Details

- 1 tasca

- 1 pocket

Taglie / Sizes

Taglia unica / One size

Art. 20P01H147

019 Grigio / Grey

Tessuto / Fabric
100% poliestere
100% polyester
170 g / m²

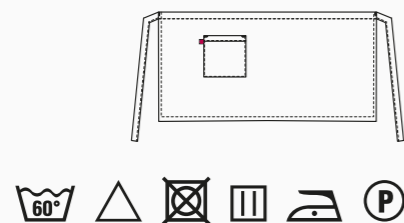

RENO

Dettagli / Details

- 2 tasche - 1 taschino portapenne
- Allacciatura collo regolabile

- 2 pockets - 1 pen pocket
- Adjustable halter

Taglie / Sizes

Taglia unica / One size

Art. 20P01H158

019 Grigio / Grey

Tessuto / Fabric
100% poliestere
100% polyester
170 g / m²

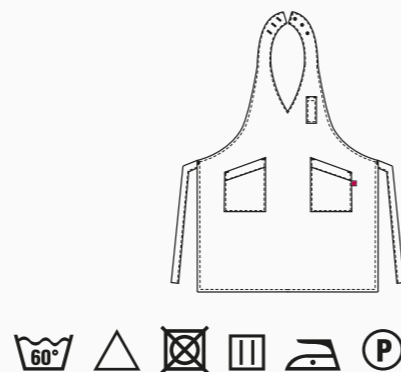

LIONE

Dettagli / Details

- 1 tasca

- 1 pocket

Taglie / Sizes

Taglia unica / One size

Art. 20P01H159

019 Grigio / Grey

Tessuto / Fabric
100% poliestere
100% polyester
170 g / m²

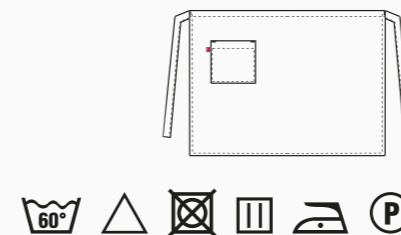

SCOTLAND

Dettagli / Details

- 1 grande tasca - 1 taschino portapenne
- Allacciatura collo regolabile con bottoni

- 1 big pocket - 1 pen pocket
- Adjustable halter with buttons

Taglie / Sizes

Taglia unica / One size

Art. 20P01H2055

019 Grigio / Grey

Tessuto / Fabric
100% poliestere
100% polyester
170 g / m²

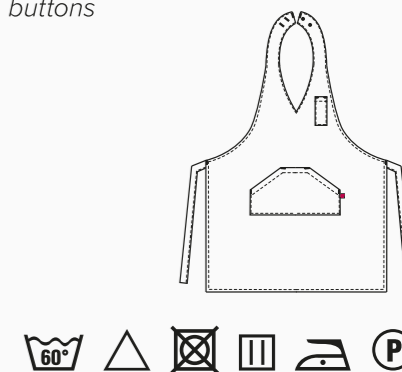



NIZZA

Dettagli / Details

- 2 tasche - 1 taschino portapenne
- Allacciatura collo regolabile
- Anello porta torcione

- 2 pockets
- 1 pen pocket
- Adjustable halter
- Cloth ring

Taglie / Sizes

Taglia unica / One size

Art. 19P01H070

019 Grigio / Grey
322 Marrone / Brown

Tessuto / Fabric

100% cotone
100% cotton
220 g / m²

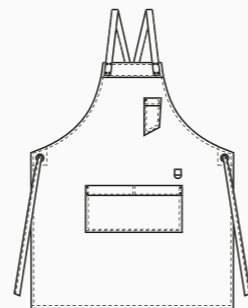

ACCESSORI COORDINABILI
COORDINABLE ACCESSORIES
pag. 375





Regali esperienze fatte di suggestioni e originalità?

Attraverso grembiuli, accessori e abiti di tendenza, con la linea **G' Glamour** puoi creare abbinamenti particolari, perfetti per andare incontro ai desideri di una clientela moderna e innovativa.

Gli indumenti giusti per te che vivi la creatività come un'occasione per offrire il meglio.

Glamour

COLLECTION

Do you give away experiences made of suggestions and originality?

*Through aprons, accessories and clothes by trend, with the **G' Glamour** line you can create particular combinations, perfect to meet to the desires of a modern and innovative clientele.*

The right clothes for you that live creativity as an opportunity to offer the best.

ho.re.ca.
& services



MIGUEL

Dettagli / Details

- 2 tasche - 4 bottoni - Fascette regolabili

- 2 pockets - 4 buttons - Adjustable buckles

Taglie / Sizes

S ÷ XXXL Regular Fit

Art. 20P01E420

S322 Marrone / Brown

Tessuto / Fabric

68% poliestere 30% viscosa 2% elasthan
68% polyester 30% viscose 2% elastane
175 g / m²

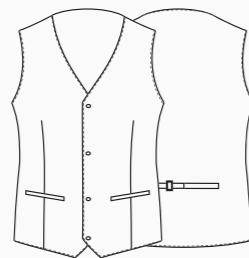

CORA

Dettagli / Details

- 2 tasche - 4 bottoni - Fascette regolabili

- 2 pockets - 4 buttons - Adjustable buckles

Taglie / Sizes

XS ÷ XXL Slim Fit

Art. 20P01E150

S322 Marrone / Brown

Tessuto / Fabric

68% poliestere 30% viscosa 2% elasthan
68% polyester 30% viscose 2% elastane
175 g / m²



DOUGLAS

Dettagli / Details

- 2 tasche - 1 taschino portapenne

- Allacciatura collo regolabile

- 2 pockets - 1 pen pocket

- Adjustable halter

Taglie / Sizes

Taglia unica / One size

Art. 20P01H013

S322 Marrone / Brown

Tessuto / Fabric

68% poliestere 30% viscosa 2% elasthan
68% polyester 30% viscose 2% elastane
175 g / m²

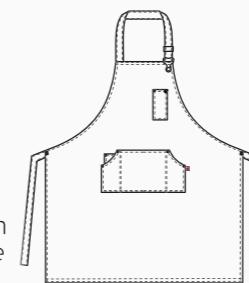

SHANNON

Dettagli / Details

- 2 tasche

- 1 taschino portapenne

- 2 pockets

- 1 pen pocket

Taglie / Sizes

Taglia unica / One size

Art. 20P01H014

S322 Marrone / Brown

Tessuto / Fabric

68% poliestere 30% viscosa 2% elasthan
68% polyester 30% viscose 2% elastane
175 g / m²

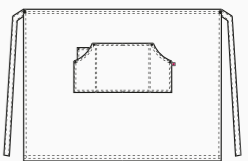



EASY CARE

EASY CARE

BRISTOL

Dettagli / Details

- 3 tasche - Taschino portapenne
- Allacciatura collo regolabile

- 3 pockets - Pen pocket
- Adjustable halter

Taglie / Sizes Taglia unica / One size

Art. 18P01H003

Q322 Marrone / Brown

Tessuto / Fabric

82% poliestere 15% cotone 3% elastan
82% polyester 15% cotton 3% elastane
170 g / m²

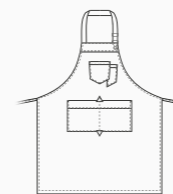

WINDSOR

Dettagli / Details

- 2 tasche
- 2 pockets

Taglie / Sizes Taglia unica / One size

Misure / Dimensions 70x80 cm

Art. 18P01H004

Q322 Marrone / Brown

Tessuto / Fabric

82% poliestere 15% cotone 3% elastan
82% polyester 15% cotton 3% elastane
170 g / m²

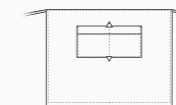

LUNA

Dettagli / Details

- 2 tasche - Taschino portapenne
- Allacciatura collo regolabile con velcro

- 2 pockets - Pen pocket
- Adjustable halter with velcro

Taglie / Sizes Taglia unica / One size

Art. 18P01H005

Q322 Marrone / Brown

Tessuto / Fabric

82% poliestere 15% cotone 3% elastan
82% polyester 15% cotton 3% elastane
170 g / m²

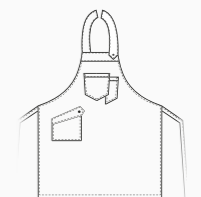

ACCESSORI COORDINABILI
COORDINABLE ACCESSORIES
pag. 373 - 376



EASY CARE



EASY CARE



BRISTOL

Dettagli / Details

- 3 tasche - Taschino portapenne
- Allacciatura collo regolabile
- 3 pockets - Pen pocket
- Adjustable halter

Taglie / Sizes Taglia unica / One size

Art. 18P01H006

Q004 Blu / Blue

Tessuto / Fabric

82% poliestere 15% cotone 3% elasthan
82% polyester 15% cotton 3% elastane
170 g / m²

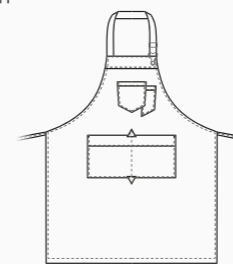

WINDSOR

Dettagli / Details

- 2 tasche
- 2 pockets

Taglie / Sizes Taglia unica / One size

Art. 18P01H007

Q004 Blu / Blue

Tessuto / Fabric

82% poliestere 15% cotone 3% elasthan
82% polyester 15% cotton 3% elastane
170 g / m²

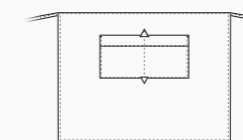

LUNA

Dettagli / Details

- 2 tasche - Taschino portapenne
- Allacciatura collo regolabile con velcro
- 2 pockets - Pen pocket
- Adjustable halter with velcro

Taglie / Sizes Taglia unica / One size

Art. 18P01H008

Q004 Blu / Blue

Tessuto / Fabric

82% poliestere 15% cotone 3% elasthan
82% polyester 15% cotton 3% elastane
170 g / m²

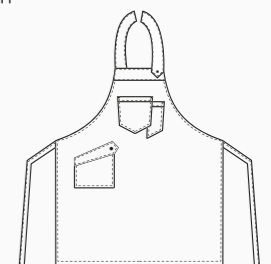

ACCESSORI COORDINABILI
COORDINABLE ACCESSORIES
pag. 373 - 376

MADRAS

Dettagli / Details

- 2 tasche
- 1 taschino portapenne
- Allacciatura collo regolabile con bottoni

- 2 pockets
- 1 pen pocket
- Adjustable halter with buttons

Taglie / Sizes

Taglia unica / One size

Art. 20P01H157

000 Nero / Black

Tessuto / Fabric

100% poliestere
100% polyester
170 g / m²

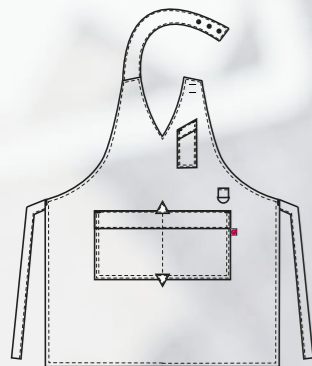

GIUDY

Dettagli / Details

- 1 tasca - 1 Taschino portapenne
- Allacciatura collo regolabile con bottoni

- 1 pocket - 1 pen pocket
- Adjustable halter with buttons

Taglie / Sizes

Taglia unica / One size

Art. 20P01H146

F024 Madras / Madras

Tessuto / Fabric

100% poliestere
100% polyester
120 g / m²

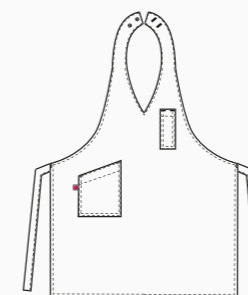

CINDY

Dettagli / Details

- 1 tasca - 1 Taschino portapenne
- Allacciatura collo regolabile con bottoni

- 1 pocket - 1 pen pocket
- Adjustable halter with buttons

Taglie / Sizes

Taglia unica / One size

Art. 20P01H155

000 Nero / Black

Tessuto / Fabric

100% poliestere
100% polyester
170 g / m²

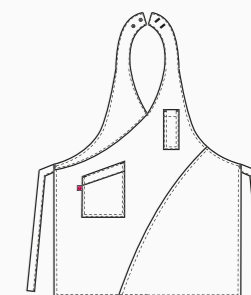

NIZZA

Dettagli / Details

- 2 tasche
- 1 taschino portapenne
- Allacciatura collo regolabile
- Anello porta torcione

- 2 pockets
- 1 pen pocket
- Adjustable halter
- Cloth ring

Taglie / Sizes

Taglia unica / One size

Art. 19P01H071

J000 Nero / Black

Tessuto / Fabric

75% cotone 23% poliestere 2% elasthan
75% cotton 23% polyester 2% elastane
210 g / m²

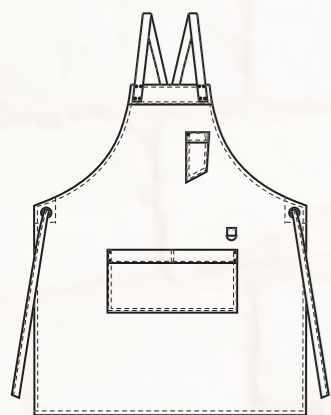

LUNA

Dettagli / Details

- 2 tasche
- 1 taschino portapenne
- Allacciatura collo regolabile con velcro

- 2 pockets
- 1 pen pocket
- Adjustable halter with velcro

Taglie / Sizes

Taglia unica / One size

Art. 19P01H069

J000 Nero / Black

Tessuto / Fabric

75% cotone 23% poliestere 2% elasthan
75% cotton 23% polyester 2% elastane
210 g / m²

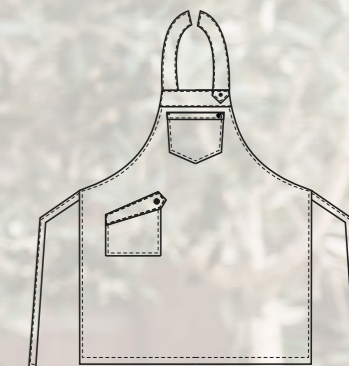

EASY CARE

EASY CARE



ANVERSA

Dettagli / Details

- 2 tasche
- Allacciatura collo regolabile con bottoni automatici

- 2 pockets
- Adjustable halter with press studs

Taglie / Sizes

Taglia unica / One size

Art. 17P01H906

004 Blu jeans / Blue jeans

Tessuto / Fabric

100% cotone / cotton
260 g / m²

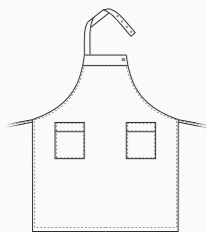

CHARLIE

Dettagli / Details

- 4 tasche
- 4 pockets

Taglie / Sizes

Taglia unica / One size

Misure / Dimensions 30x70 cm

Art. 18P01H027

004 Blue jeans / Blue jeans

Tessuto / Fabric

100% cotone / cotton
260 g / m²

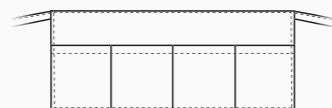

ZAGABRIA

Dettagli / Details

- 1 tasca

- 1 pocket

Taglie / Sizes

Taglia unica / One size

Misure / Dimensions 70x70 cm

Art. 18P01H028

004 Blue jeans / Blue jeans

Tessuto / Fabric

100% cotone / cotton
260 g / m²

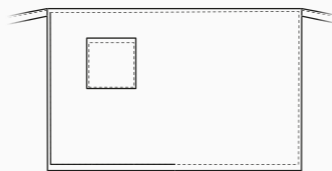

EASY CARE



EASY CARE



EASY CARE



EASY CARE



CAMBRIDGE

Dettagli / Details

- 2 tasche - Taschino portapenne
- Allacciatura collo regolabile

- 2 pockets - Pen pocket
- Adjustable halter

Taglie / Sizes

Taglia unica / One size

Art. 18P01H015

J118 Jeans chiaro / Light jeans

Tessuto / Fabric

100% cotone
100% cotton
260 g / m²

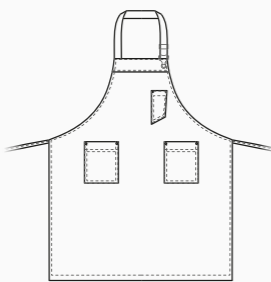

WINDSOR

Dettagli / Details

- 2 tasche
- 2 pockets

Taglie / Sizes

Taglia unica / One size

Misure / Dimensions 70x80 cm

Art. 18P01H016

J118 Jeans chiaro / Light jeans

Tessuto / Fabric

100% cotone
100% cotton
260 g / m²

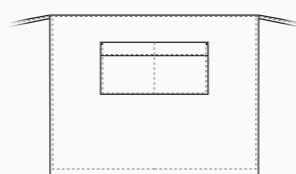

DOUGLAS

Dettagli / Details

- 3 tasche - 2 taschini portapenne
- Allacciatura collo regolabile

- 3 pockets - 2 pen pockets
- Adjustable halter

Taglie / Sizes

Taglia unica / One size

Art. 18P01H013

004 Blu jeans / Blue jeans

Tessuto / Fabric

100% cotone
100% cotton
260 g / m²

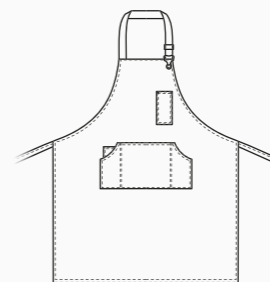

SHANNON

Dettagli / Details

- 3 tasche
- Taschino portapenne

- 3 pockets
- 1 pen pocket

Taglie / Sizes

Taglia unica / One size

Misure / Dimensions 70x80 cm

Art. 18P01H014

004 Blu jeans / Blue jeans

Tessuto / Fabric

100% cotone
100% cotton
260 g / m²

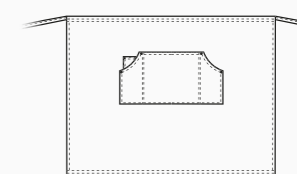

TUCSON

Dettagli / Details

- 3 tasche
- 2 taschini portapenne
- Allacciatura collo regolabile
- Laccio collo removibile

- 3 pockets
- 2 pen pockets
- Adjustable halter
- Removable neckline

Taglie / Sizes

Taglia unica / One size



Art. 20P01H161

000 Nero / Black
102 Verde militare / Military green

Tessuto / Fabric

85% cotone 15% poliestere
85% cotton 15% polyester
290 g / m²

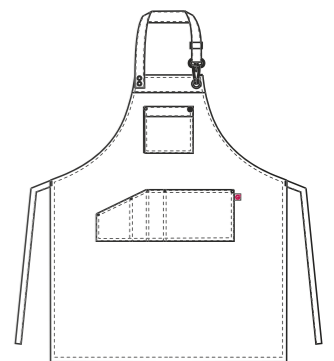

Art. 20P01H161
000 Nero / Black

Art. 20P01H161
102 Verde militare / Military green



DAKOTA

Dettagli / Details

- 2 tasche
- 2 taschini portapenne
- Allacciatura collo regolabile
- Inserti in finta pelle

- 2 pockets
- Pen pocket
- Adjustable halter
- Fake leather inserts

Taglie / Sizes

Taglia unica / One size



Art. 20P01H160

117 Ocra / Ochre
119 Grigio / Grey

Tessuto / Fabric

100% cotone
100% cotton
260 g / m²

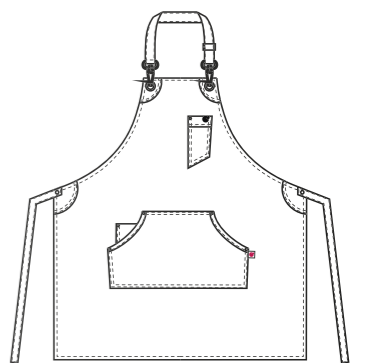

Art. 20P01H160
117 Ocra / Ochre

Art. 20P01H160
119 Grigio / Grey

OREGON

Dettagli / Details

- 3 tasche
- Allacciatura collo regolabile
- Anello porta torcione

- 3 pockets
- Adjustable halter
- Cloth ring

Taglie / Sizes

Taglia unica / One size



Art. 19P01H067

R004 Blu / Blue
R006 Bordeaux / Burgundy

Tessuto / Fabric

85% cotone 15% poliestere
85% cotton 15% polyester
293 g / m²

ACCESSORI COORDINABILI
COORDINABLE ACCESSORIES
pag. 375

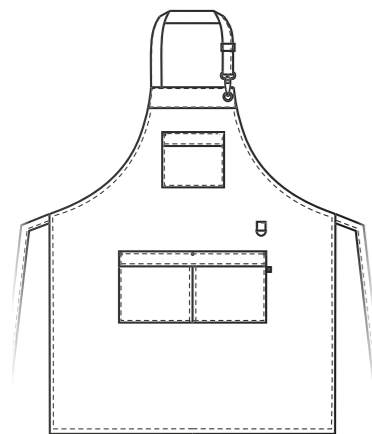

Art. 19P01H067
R006 Bordeaux / Burgundy



Art. 19P01H067
R004 Blu / Blue

RYAN

Dettagli / Details

- 3 tasche
- Allacciatura collo regolabile
- Inserti in alcantara

- 3 pockets
- Adjustable halter
- Inserts in alcantara

Taglie / Sizes

Taglia unica / One size



Art. 20P01H156

102 Verde militare / Military green
000 Nero / Black

Tessuto / Fabric

65% poliestere 35% cotone
65% polyester 35% cotton
200 g / m²

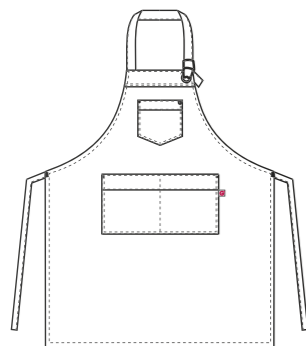

Art. 20P01H156
000 Nero / Black



Art. 20P01H156
102 Verde militare / Military green

DALLAS

Dettagli / Details

- 3 tasche
- Allacciatura collo regolabile
- Stone wash

- 3 pockets
- Adjustable halter
- Stone wash

Taglie / Sizes

Taglia unica / One size

Art. 19P01H076

000 Nero / Black
119 Grigio / Grey
002 Verde / Green

Tessuto / Fabric

100% cotone
100% cotton
260 g / m²



Art. 19P01H076
000 Nero / Black



Art. 19P01H076
119 Grigio / Grey



Art. 19P01H076
002 Verde / Green

IL TRATTAMENTO
STONE WASH RENDE
OGNI CAPO DIVERSO
DAGLI ALTRI

THE STONE WASH
TREATMENT MAKES
EVERY PRODUCT
DIFFERENT
FROM THE OTHERS

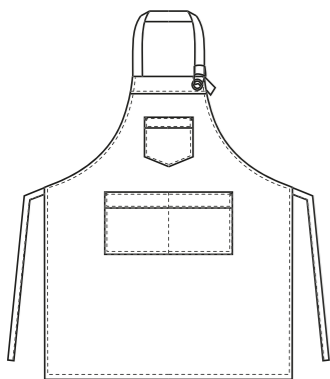

AUSTIN

Dettagli / Details

- Stone wash
- 2 tasche

- 2 pockets
- Stone wash

Taglie / Sizes

Taglia unica / One size

Art. 19P01H082

000 Nero / Black
119 Grigio / Grey
002 Verde / Green

Tessuto / Fabric

100% cotone
100% cotton
260 g / m²



Art. 19P01H082
119 Grigio / Grey



Art. 19P01H082
002 Verde / Green

IL TRATTAMENTO
STONE WASH RENDE
OGNI CAPO DIVERSO
DAGLI ALTRI

THE STONE WASH
TREATMENT MAKES
EVERY PRODUCT
DIFFERENT
FROM THE OTHERS

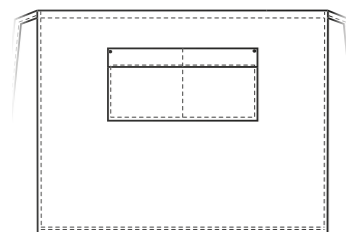

Art. 19P01H082
000 Nero / Black

KANSAS

Dettagli / Details

- 2 tasche
- Allacciatura collo regolabile

- 2 pockets
- Adjustable halter

Taglie / Sizes

Taglia unica / One size

Art. 20P01H073

322 Marrone / Brown

Tessuto 1 / Fabric 1

75% cotone 23% poliestere 2% elasthan
75% cotton 23% polyester 2% elastane
210 g / m²

Tessuto 2 / Fabric 2

65% poliestere 35% cotone
65% polyester 35% cotton
200 g / m²

Tessuto 3 / Fabric 3

92% poliestere 8% elasthan
92% polyester 8% elastane
247 g / m²

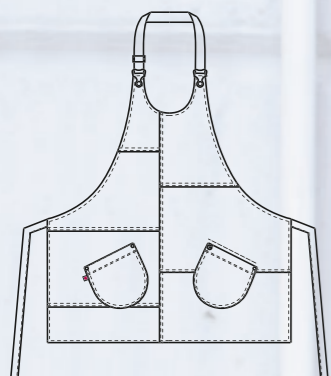

CALIFORNIA

Dettagli / Details

- 2 tasche
- 1 taschino portapenne
- Allacciatura collo regolabile

- 2 pockets
- 1 pen pocket
- Adjustable halter

Taglie / Sizes

Taglia unica / One size

Art. 20P01H072

322 Marrone / Brown

Tessuto 1 / Fabric 1

75% cotone 23% poliestere 2% elasthan
75% cotton 23% polyester 2% elastane
210 g / m²

Tessuto 2 / Fabric 2

65% poliestere 35% cotone
65% polyester 35% cotton
200 g / m²

Tessuto 3 / Fabric 3

92% poliestere 8% elasthan
92% polyester 8% elastane
247 g / m²

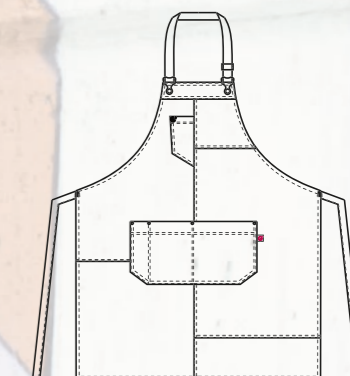

CALIFORNIA

Dettagli / Details

- 2 tasche
- 1 taschino portapenne
- Allacciatura collo regolabile

- 2 pockets
- 1 pen pocket
- Adjustable halter

Taglie / Sizes

Taglia unica / One size

Art. 19P01H072

J004 Blu / Blue

Tessuto 1 / Fabric 1

100% cotone
100% cotton
260 g / m²

Tessuto 2 / Fabric 2

100% poliestere
100% polyester
170 g / m²

Tessuto 3 / Fabric 3

92% poliestere 8% elasthan
92% polyester 8% elastane
247 g / m²

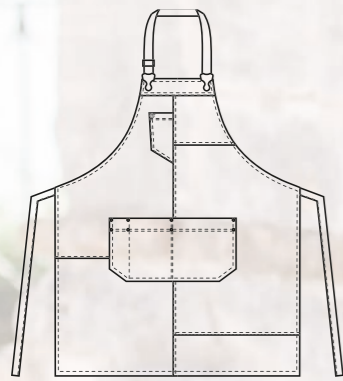

KANSAS

Dettagli / Details

- 2 tasche
- Allacciatura collo regolabile

- 2 pockets
- Adjustable halter

Taglie / Sizes

Taglia unica / One size

Art. 19P01H073

J004 Blu / Blue

Tessuto 1 / Fabric 1

100% cotone
100% cotton
260 g / m²

Tessuto 2 / Fabric 2

100% poliestere
100% polyester
170 g / m²

Tessuto 3 / Fabric 3

92% poliestere 8% elasthan
92% polyester 8% elastane
247 g / m²

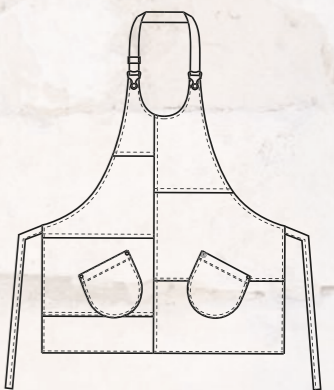



EASY CARE

EASY CARE

MANCHESTER

Dettagli / Details

- 3 tasche - Taschino portapenne
- Allacciatura collo regolabile
- Anello porta torcione

- 3 pockets - Pen pocket
- Adjustable halter
- Cloth ring

Taglie / Sizes

Taglia unica / One size

Art. 18P01H019

000 Nero / Black

Tessuto / Fabric

65% poliestere 35% cotone
65% polyester 35% cotton
200 g / m²

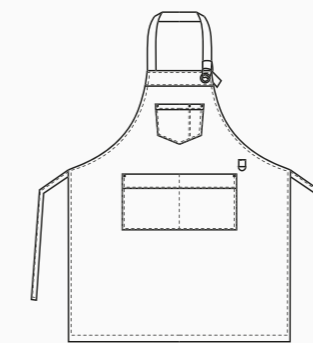

LUNA

Dettagli / Details

- 2 tasche - Taschino portapenne
- Allacciatura collo regolabile con velcro

- 2 pockets - Pen pocket
- Adjustable halter with velcro

Taglie / Sizes

Taglia unica / One size

Art. 18P01H020

000 Nero / Black

Tessuto / Fabric

65% poliestere 35% cotone
65% polyester 35% cotton
200 g / m²

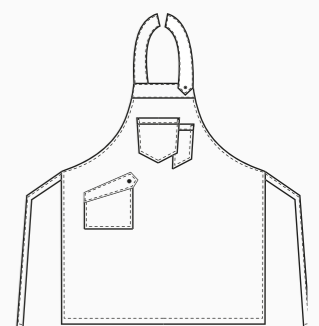



EASY CARE



EASY CARE



LUNA

Dettagli / Details

- 2 tasche - Taschino portapenne
- Allacciatura collo regolabile con velcro

- 2 pockets - Pen pocket
- Adjustable halter with velcro

Taglie / Sizes

Taglia unica / One size

Art. 18P01H018

073 Beige / Beige

Tessuto / Fabric

100% cotone
100% cotton
250 g / m²

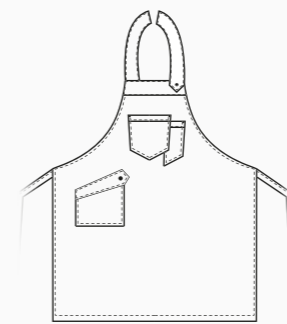

MANCHESTER

Dettagli / Details

- 3 tasche - Taschino portapenne
- Allacciatura collo regolabile
- Anello porta torcione

- 3 pockets - Pen pocket
- Adjustable halter
- Cloth ring

Taglie / Sizes

Taglia unica / One size

Art. 18P01H017

073 Beige / Beige

Tessuto / Fabric

100% cotone
100% cotton
250 g / m²

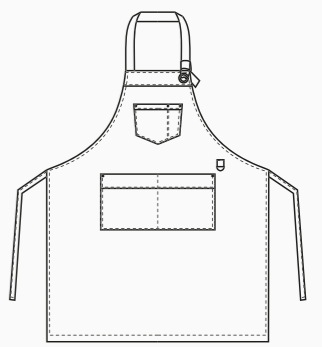

EASY CARE



EASY CARE



MANCHESTER

Dettagli / Details

- 3 tasche - Taschino portapenne
- Allacciatura collo regolabile
- Anello porta torcione

- 3 pockets - Pen pocket
- Adjustable halter
- Cloth ring

Taglie / Sizes

Taglia unica / One size

Art. 19P01H114

016 Tortora / Taupe

Tessuto / Fabric

65% poliestere 35% cotone
65% polyester 35% cotton
200 g / m²



Art. 19P01H115

J004 Jeans blu / Blue jeans

Tessuto / Fabric

100% cotone
100% cotton
260 g / m²

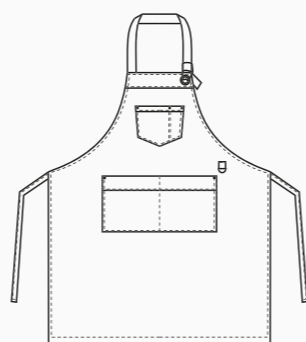

TYRON

Dettagli / Details

- Sfoderato - 2 tasche
- 6 bottoni automatici
- Fascette regolabili

- Unlined - 2 pockets
- 6 press studs
- Adjustable buckle

Taglie / Sizes

S ÷ XXXL Slim Fit

Art. 19P01E091

322 Marrone / Brown

Tessuto / Fabric

55% viscosa 45% poliuretano
55% viscose 45% polyurethane
254 g / m²

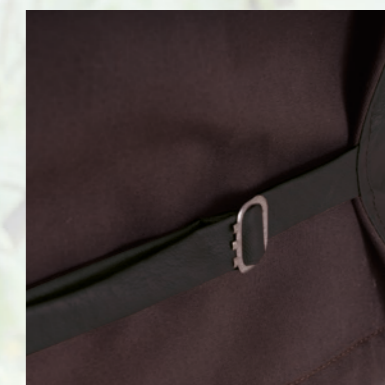
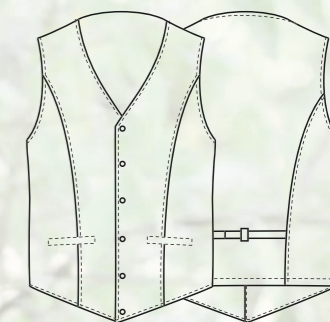

EASY CARE



EASY CARE



EASY CARE



EASY CARE



YORK

Dettagli / Details

-2 tasche - 3 taschini portapenne
-Allacciatura collo regolabile

-2 pockets - 3 pen pockets
- Adjustable halter

Taglie / Sizes

Taglia unica / One size

Art. 18P01H021

322 Marrone / Brown

Tessuto / Fabric

55% viscosa 45% poliuretano
55% viscose 45% polyurethane
254 g / m²

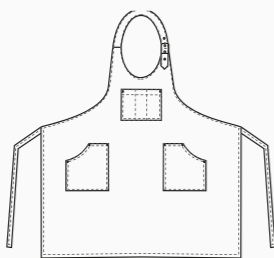

CITY

Dettagli / Details

-3 tasche

-3 pockets

Taglie / Sizes

Taglia unica / One size

Misure / Dimensions 71,5x110 cm

Art. 18P01H022

322 Marrone / Brown

Tessuto / Fabric

55% viscosa 45% poliuretano
55% viscose 45% polyurethane
254 g / m²

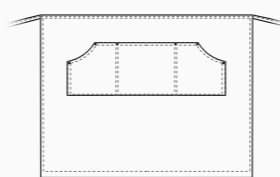

MELANY

Dettagli / Details

-3 tasche - Allacciatura collo regolabile

-3 pockets - Adjustable halter

Taglie / Sizes

Taglia unica / One size

Art. 18P01H023

322 Marrone / Brown

Tessuto / Fabric

55% viscosa 45% poliuretano
55% viscose 45% polyurethane
254 g / m²

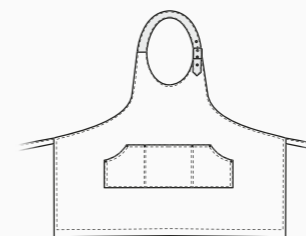

MANHATTAN

Dettagli / Details

-3 tasche

-3 pockets

Taglie / Sizes

Taglia unica / One size

Misure / Dimensions 32x77 cm

Art. 18P01H024

322 Marrone / Brown

Tessuto / Fabric

55% viscosa 45% poliuretano
55% viscose 45% polyurethane
254 g / m²

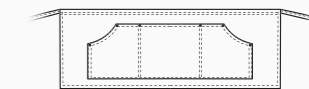

MAGRITTE

Dettagli / Details

- Tela impermeabile
- 3 grandi tasche
- 3 taschini portapenne
- Allacciatura collo regolabile

- Waterproof canvas
- 3 big pockets
- 3 pen pockets
- Adjustable halter

Taglie / Sizes

Taglia unica / One size

Art. 19P01H080

016 Tortora / Taupe

Tessuto 1 / Fabric 1

100% poliestere
100% polyester
215 g / m²

Tessuto 2 / Fabric 2

55% viscosa 45% poliuretano
55% viscose 45% polyurethane
254 g / m²

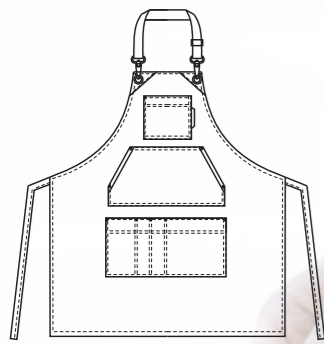

GAUGUIN

Dettagli / Details

- Tela impermeabile
- 3 grandi tasche
- 3 taschini portapenne
- Allacciatura collo regolabile

- Waterproof canvas
- 3 big pockets
- 3 pen pockets
- Adjustable halter

Taglie / Sizes

Taglia unica / One size

Art. 19P01H079

004 Blu / Blue

Tessuto 1 / Fabric 1

100% poliestere
100% polyester
215 g / m²

Tessuto 2 / Fabric 2

55% viscosa 45% poliuretano
55% viscose 45% polyurethane
254 g / m²

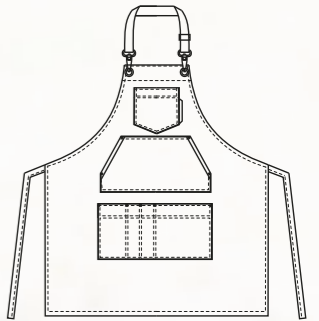

LUGANO

Dettagli / Details

- 3 tasche
- Allacciatura collo regolabile
- Inserti in Alcantara

- 3 pockets
- Adjustable halter
- Alcantara inserts

Taglie / Sizes

Taglia unica / One size

Art. 19P01H074

S119 Grigio / Grey

Tessuto / Fabric

82% poliestere 15% cotone 3% elastan
82% polyester 15% cotton 3% elastane
172 g / m²

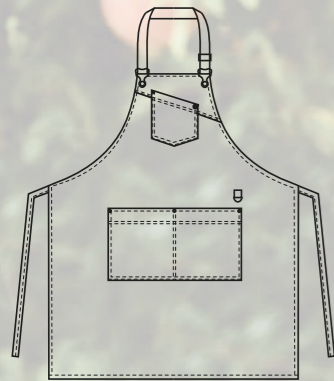

PICASSO

Dettagli / Details

- Tela impermeabile
- 3 grandi tasche
- 3 taschini portapenne
- Allacciatura collo regolabile
- Inserti in Alcantara

- Waterproof canvas
- 3 big pockets
- 3 pen pockets
- Adjustable halter
- Alcantara inserts

Taglie / Sizes

Taglia unica / One size

Art. 19P01H081

000 Nero / Black

Tessuto / Fabric

100% poliestere
100% polyester
215 g / m²

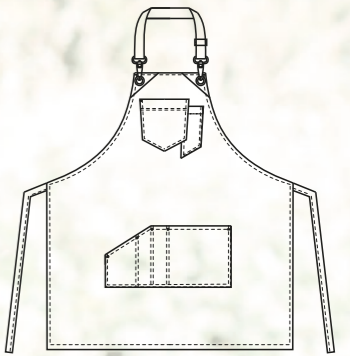



Ti dedichi a un pubblico amante degli stili classici e lontano dalle mode passeggere?

Nella collezione **G'Evergreen** puoi trovare gilet, camicie, accessori e abiti dal mood intramontabile.

Capi adatti ad ogni occasione, pensati per te che conosci il fascino della discrezione e sai trasformare la semplicità in un privilegio. Insostituibili compagni di viaggio per chi sa accogliere con classe, creando atmosfere fuori dal tempo.

Evergreen

COLLECTION

You dedicate yourself to a public that loves classic styles and far from passing fashions?

*In the **G' Evergreen** collection you can find vests, shirts, accessories and dresses with a timeless mood. Clothes suitable for every occasion, designed for you that you know the charm of discretion and you know transform simplicity into a privilege. Irreplaceable traveling companions for those who know how to welcome with class, creating timeless atmospheres.*

ho.re.ca.
& services



NAPOLI

Dettagli / Details

- 1 tasca
- 1 pocket

Taglie / Sizes Taglia unica / One size

Misure / Dimensions 43x70 cm

Art. 423

000 Nero / Black

Tessuto / Fabric

100% poliestere / polyester - 220 g / m²



FERRARA

Dettagli / Details

- 2 tasche - 1 portapenne
- Allacciatura collo regolabile con bottone
- 2 pockets - 1 penpocket
- Adjustable halter with button

Taglie / Sizes Taglia unica / One size

Art. 424

000 Nero / Black

Tessuto / Fabric

100% poliestere / polyester - 220 g / m²

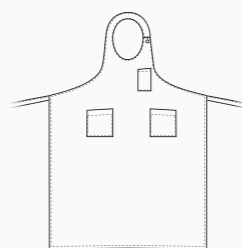

LIONE

Dettagli / Details

- 1 tasca
- 1 pocket

Taglie / Sizes Taglia unica / One size

Misure / Dimensions 68x98 cm

Art. 422

000 Nero / Black

Tessuto / Fabric

100% poliestere / polyester - 220 g / m²

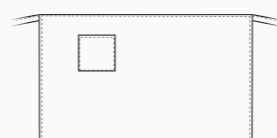

NAPOLI

Dettagli / Details

- 1 tasca
- 1 pocket

Taglie / Sizes Taglia unica / One size

Misure / Dimensions 43x70 cm

Art. 423BX

006 Bordeaux / Burgundy

Tessuto / Fabric

100% poliestere / polyester - 220 g / m²



FERRARA

Dettagli / Details

- 2 tasche - 1 portapenne
- Allacciatura collo regolabile con bottone
- 2 pockets - 1 penpocket
- Adjustable halter with button

Taglie / Sizes Taglia unica / One size

Art. 424BX

006 Bordeaux / Burgundy

Tessuto / Fabric

100% poliestere / polyester - 220 g / m²

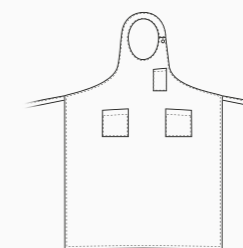

LIONE

Dettagli / Details

- 1 tasca
- 1 pocket

Taglie / Sizes Taglia unica / One size

Misure / Dimensions 68x98 cm

Art. 422BX

006 Bordeaux / Burgundy

Tessuto / Fabric

100% poliestere / polyester - 220 g / m²

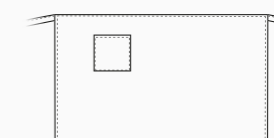



NAPOLI

Dettagli / Details

- 1 tasca

- 1 pocket

Taglie / Sizes

Taglia unica / One size

Art. 20P01H423

G000 Nero / Black

Tessuto / Fabric

99% poliestere 1% viscosa
99% polyester 1% viscose
170 g / m²

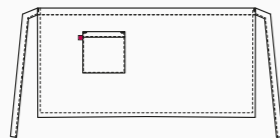

RENO

Dettagli / Details

- 2 tasche - 1 taschino portapenne
- Allacciatura collo regolabile con bottoni

- 2 pockets - 1 pen pocket
- Adjustable halter with buttons

Taglie / Sizes

Taglia unica / One size

Art. 20P01H152

G000 Nero / Black

Tessuto / Fabric

99% poliestere 1% viscosa
99% polyester 1% viscose
170 g / m²

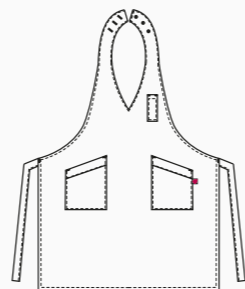

SENNA

Dettagli / Details

- 2 tasche
- Allacciatura collo regolabile con bottoni

- 2 pockets
- Adjustable halter with buttons

Taglie / Sizes

Taglia unica / One size

Art. 20P01H153

G000 Nero / Black

Tessuto / Fabric

99% poliestere 1% viscosa
99% polyester 1% viscose
170 g / m²

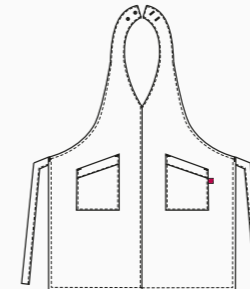

RODANO

Dettagli / Details

- 1 tasca

- 1 pocket

Taglie / Sizes

Taglia unica / One size

Art. 20P01H154

G000 Nero / Black

Tessuto / Fabric

99% poliestere 1% viscosa
99% polyester 1% viscose
170 g / m²

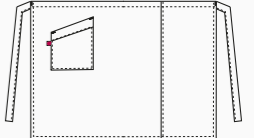



Giblor's
italian worklife specialist

Grembiule **SENNA**
pag. 267

ACCESSORI
pag. 356

Grembiule **RODANO**
pag. 267



NAPOLI

Dettagli / Details

- 1 tasca

- 1 pocket

Taglie / Sizes

Taglia unica / One size

Art. 20P01H423

G119 Grigio / Grey

Tessuto / Fabric

99% poliestere 1% viscosa
99% polyester 1% viscose
170 g / m²

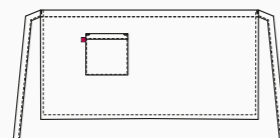

RENO

Dettagli / Details

- 2 tasche - 1 taschino portapenne
- Allacciatura collo regolabile con bottoni

- 2 pockets - 1 pen pocket
- Adjustable halter with buttons

Taglie / Sizes

Taglia unica / One size

Art. 20P01H152

G119 Grigio / Grey

Tessuto / Fabric

99% poliestere 1% viscosa
99% polyester 1% viscose
170 g / m²

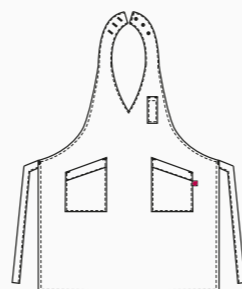

SENNA

Dettagli / Details

- 2 tasche
- Allacciatura collo regolabile con bottoni

- 2 pockets
- Adjustable halter with buttons

Taglie / Sizes

Taglia unica / One size

Art. 20P01H153

G119 Grigio / Grey

Tessuto / Fabric

99% poliestere 1% viscosa
99% polyester 1% viscose
170 g / m²

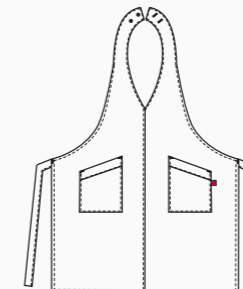

RODANO

Dettagli / Details

- 1 tasca

- 1 pocket

Taglie / Sizes

Taglia unica / One size

Art. 20P01H154

G119 Grigio / Grey

Tessuto / Fabric

99% poliestere 1% viscosa
99% polyester 1% viscose
170 g / m²

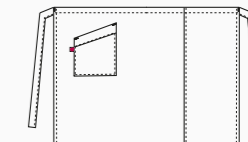



RENO
pag. 270



ACCESSORI
pag. 356



RODANO
pag. 271



SENNÀ
pag. 271





NAPOLI

Dettagli / Details

- 1 tasca

- 1 pocket

Taglie / Sizes

Taglia unica / One size

Art. 20P01H423

G006 Bordeaux / Burgundy

Tessuto / Fabric

99% poliestere 1% viscosa
99% polyester 1% viscose
170 g / m²

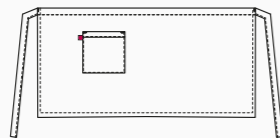

RENO

Dettagli / Details

- 2 tasche - 1 taschino portapenne
- Allacciatura collo regolabile con bottoni

- 2 pockets - 1 pen pocket
- Adjustable halter with buttons

Taglie / Sizes

Taglia unica / One size

Art. 20P01H152

G006 Bordeaux / Burgundy

Tessuto / Fabric

99% poliestere 1% viscosa
99% polyester 1% viscose
170 g / m²

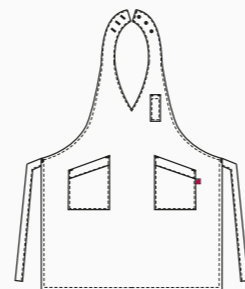

SENNA

Dettagli / Details

- 2 tasche
- Allacciatura collo regolabile con bottoni

- 2 pockets
- Adjustable halter with buttons

Taglie / Sizes

Taglia unica / One size

Art. 20P01H153

G006 Bordeaux / Burgundy

Tessuto / Fabric

99% poliestere 1% viscosa
99% polyester 1% viscose
170 g / m²

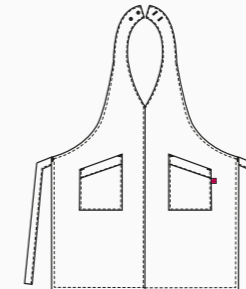

RODANO

Dettagli / Details

- 1 tasca

- 1 pocket

Taglie / Sizes

Taglia unica / One size

Art. 20P01H154

G006 Bordeaux / Burgundy

Tessuto / Fabric

99% poliestere 1% viscosa
99% polyester 1% viscose
170 g / m²

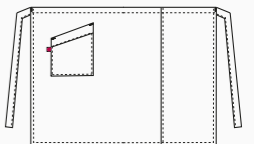

ELETTRA

Dettagli / Details

- 1 tasca
- Allacciatura collo regolabile con velcro

- 1 pocket
- Adjustable halter with velcro

Taglie / Sizes

Taglia unica / One size

Art. 14P02H455

Art. 15P01H455

Art. 19P01H455

Tessuto / Fabric

65% poliestere 35% cotone
65% polyester 35% cotton
200 g / m²



Art. 14P02H455
016 Tortora / Toupe



Art. 15P01H455
7014F Moka / Moka



Art. 15P01H455
000 Nero / Black

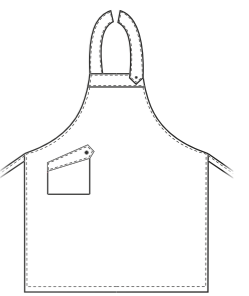

Art. 19P01H455
006 Bordeaux / Burgundy



Art. 19P01H455
033 Corallo / Coral



Art. 19P01H455
214 Petrolio / Petroleum blue



Art. 19P01H455
122 Bruciato / Burnt



ELETTRA
Art. 19P01H455
214 Petrolio / Petroleum blue

AMSTERDAM
Art. 19P01H440
214 Petrolio / Petroleum blue

AMSTERDAM



Dettagli / Details
 - 2 tasche
 - 2 pockets

Taglie / Sizes
 Taglia unica / One size

Art. 14P01H440
Art. 15P01H440
Art. 1100
Art. 19P01H440

Tessuto / Fabric
 65% poliestere 35% cotone
 65% polyester 35% cotton
 200 g / m²

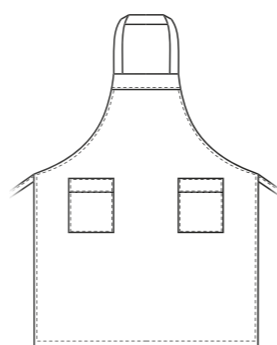

Art. 14P01H440
 016 Tortora / Taupe



Art. 15P01H440
 7014F Moka / Moka



Art. 1100
 000 Nero / Black



PRAGA

Dettagli / Details
 - 1 tasca
 - 1 pocket

Taglie / Sizes
 Taglia unica / One size

Art. 14P01H441
Art. 15P01H441
Art. 8M1641
Art. 19P01H441

Misure / Dimensions
 67x90 cm

Tessuto / Fabric
 65% poliestere 35% cotone
 65% polyester 35% cotton
 200 g / m²

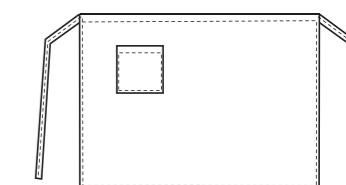

Art. 14P01H441
 016 Tortora / Taupe



Art. 15P01H441
 7014F Moka / Moka



Art. 8M1641
 000 Nero / Black



Art. 1100

006 Bordeaux / Burgundy



Art. 19P01H440

033 Corallo / Coral



Art. 19P01H440

214 Petrolio / Petroleum blue



Art. 19P01H440

122 Bruciato / Burnt



Art. 19P01H441

006 Bordeaux / Burgundy



Art. 19P01H441

033 Corallo / Coral



Art. 19P01H441

214 Petrolio / Petroleum blue



Art. 19P01H441

122 Bruciato / Brunt





Giblor's
italian worklife specialist

Grebiule **ELETTRA**
pag. 273

Giacca **VERSILIA**
pag. 48

Grebiule **PRAGA**
pag. 275

EASY CARE



EASY CARE



BIG
100X70 CM



BIG
100X100 CM



ANVERSA

Dettagli / Details

- 2 tasche
- Allacciatura collo regolabile con bottoni automatici

- 2 pockets
- Adjustable halter with press studs

Taglie / Sizes

Taglia unica / One size

Art. 17P01H905

002 Verde militare / Military green
119 Grigio / Grey

Tessuto / Fabric

65% poliestere 35% cotone
65% polyester 35% cotton
200 g / m²

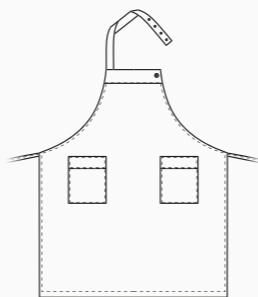

MOSCA

Dettagli / Details

- 1 tasca
- 1 pocket

Taglie / Sizes Taglia unica / One size

Misure / Dimensions 70x100 cm

Art. 17P01H908

00 Bianco / White

Tessuto / Fabric

100% cotone / cotton
180 g / m²

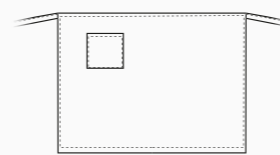

SAN PIETROBURGO

Dettagli / Details

- 2 tasche - Allacciatura collo regolabile con bottoni automatici
- 2 pockets - Adjustable halter with press studs

Taglie / Sizes Taglia unica / One size

Art. 17P01H907

00 Bianco / White

Tessuto / Fabric

100% cotone / cotton
180 g / m²

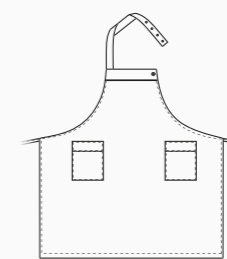

SAN PIETROBURGO

Dettagli / Details

- 2 tasche - Allacciatura collo regolabile con bottoni automatici
- 2 pockets - Adjustable halter with press studs

Taglie / Sizes Taglia unica / One size

Art. 17P01H909

000 Nero / Black

Tessuto / Fabric

65% poliestere 35% cotone
65% polyester 35% cotton
200 g / m²

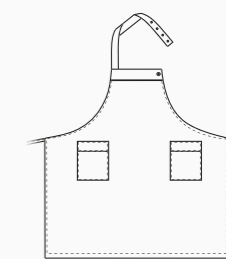

SCOTLAND

Dettagli / Details

- 1 grande tasca
- 1 taschino portapenne
- Allacciatura collo regolabile con velcro

- 1 big pocket
- 1 pen pocket
- Adjustable halter with velcro

Taglie / Sizes

Taglia unica / One size

- Art. 9M1914
- Art. 10M2055
- Art. 16P01H2055
- Art. 19P01H2055

Tessuto / Fabric

100% poliestere
100% polyester
180 g / m²

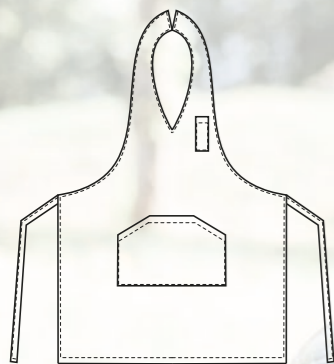

ACCESSORI COORDINABILI
COORDINABLE ACCESSORIES
pag. 377



Art. 9M1914
005 Rosso / Red



Art. 9M1914
465 Arancione / Orange



Art. 9M1914
390 Giallo / Yellow



Art. 9M1914
2019 Pistacchio / Pistachio



Art. 10M2055
077 Grigio / Grey



Art. 10M2055
006 Bordeaux / Burgundy



Art. 10M2055
000 Nero / Black



Art. 16P01H2055
322 Marrone / Brown



Art. 16P01H2055
12 Fucsia / Fuchsia



Art. 19P01H2055
025 Lilla / Lilac

LONDON

Dettagli / Details

- Scamiciato
- 1 grande tasca
- Coperto dietro

- Pinafore
- 1 big pocket
- Covered backside

Taglie / Sizes

Taglia unica / One size

Art. 9M1913
 Art. 10M2057
 Art. 15P01H612
 Art. 16P01H2057
 Art. 19P01H2057

Tessuto / Fabric

100% poliestere
 100% polyester
 180 g / m²



ACCESSORI COORDINABILI
 COORDINABLE ACCESSORIES
 pag. 377



Art. 9M1913
 005 Rosso / Red



Art. 9M1913
 465 Arancione / Orange



Art. 9M1913
 390 Giallo / Yellow



Art. 9M1913
 2019 Pistacchio / Pistachio



Art. 10M2057
 000 Nero / Black



Art. 10M2057
 077 Grigio / Grey



Art. 10M2057
 006 Bordeaux / Burgundy



Art. 15P01H612
 00 Bianco / White



Art. 16P01H2057
 322 Marrone / Brown



Art. 16P01H2057
 12 Fucsia / Fuchsia



Art. 19P01H2057
 025 Lilla / Lilac

CHARLIE

Dettagli / Details

- 4 tasche

- 4 pockets

Taglie / Sizes

Taglia unica / One size

Art. 9M1917
Art. 10M2056
Art. 16P01H2056
Art. 19P01H2056

Tessuto / Fabric

100% poliestere
100% polyester
180 g / m²



ACCESSORI COORDINABILI
COORDINABLE ACCESSORIES
pag. 377



Art. 9M1917
005 Rosso / Red



Art. 9M1917
465 Arancione / Orange



Art. 9M1917
390 Giallo / Yellow



Art. 9M1917
2019 Pistacchio / Pistachio



Art. 10M2056
077 Grigio / Grey



Art. 10M2056
006 Bordeaux / Burgundy



Art. 10M2056
000 Nero / Black



Art. 16P01H2056
322 Marrone / Brown



Art. 16P01H2056
12 Fucsia / Fuchsia



Art. 19P01H2056
025 Lilla / Lilac



Art. 414



Art. 441



Art. 481



Art. 482

MARY

Taglie / Sizes
Taglia unica / One size

Art. 414
00 Bianco / White

Tessuto / Fabric
100% cotone
100% cotton
130 g / m²



ANTONIA

Taglie / Sizes
Taglia unica / One size

Art. 441
00 Bianco / White

Tessuto / Fabric
52% poliestere 48% cotone
52% polyester 48% cotton
171 g / m²



GREMBIULE

Taglie / Sizes
Taglia unica / One size

Art. 481
Art. 482
00 Bianco / White

Tessuto / Fabric
100% cotone
100% cotton
185 g / m²



ROSY

Taglie / Sizes
Taglia unica / One size

Art. 417
00 Bianco / White

Tessuto / Fabric
100% cotone
100% cotton
185 g / m²

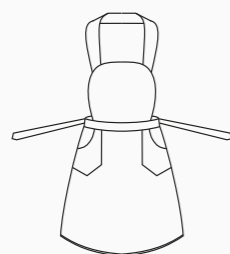

ADELINA

Taglie / Sizes
Taglia unica / One size

Art. 440
00 Bianco / White

Tessuto / Fabric
52% poliestere 48% cotone
52% polyester 48% cotton
171 g / m²

